





 **NEVA**  
**LIGHT**



“Enerjiye Dair Ne Varsa”



**GÜNEŞ ENERJİLİ**  
ARMATÜRLER PROJEKTÖRLER

6



**OTURMA GRUPLARI**  
METAL PLASTİK KAPLAMA  
PARK BAHÇE AYFINLATMA  
ARMATÜRLERİ

46



**TRAFİK GÜVENLİĞİ ÜRÜNLERİ**  
TRAFİK LEVHALARI  
FLAŞÖRLER  
SINYAL VERİCİLER

62



**SOLAR PANEL SİSTEMELERİ**  
SOLAR POWER SİSTEMLERİ  
1-3KW PAKET SİSTEMLERİ  
TARIMSAL SULAMA PAKETLERİ

96



## “Enerjiye Dair Ne Varsa”

2006 Yılında Kazanmış olduğu sektör tecrübesini 2017 yılı itibariyle NevaLight Solar Aydınlatma Sis. İml. San. ve Tic. Ltd. Şti. olarak sürdürmeye devam eden firmamız, enerji sistemleri, güneş panelleri, solar pompa, inverter ve solar Ekipmanların, tedarikçisi jel akü, led aydınlatma ürünleri ve solar kent mobilyaları üreticisidir.

Bu ürünlerin yanı sıra proje danışmanlık, enerji uygulama ve enerji sistemleri montajı taahhüttü alanlarında sektörde ilk akla gelen isimlerdendir.

Edinilen tecrübeler ile imalat yönünde hedeflerine 2015 yılında ilk adımını atarak Aydınlatma armatürlerinin kompakt bir yapı haline getirmek için ARGE çalışmalarına başlamıştır. Solar panel imalatını bünyesine katarak 2017'nin son çeyreğinde üretim hattı kurarak solar panel teknolojisinin Aydınlatma Armatürleri ile kompakt bir yapıda birleştirmeyi başarmıştır.

Hali hazırda 1000 m2 üretim hattı ile adetli seri üretim yapabilecek personel ve ekipmana sahiptir. “Gelecek ışığın” ilkesi ile yolunda emin adımlarla ilerlemektedir.





Our company which gained experience in 2006 and continued as NevaLight Solar Aydınlatma Sis. İml. San. ve Tic. Ltd. Şti. as of 2017 is the supplier of energy systems, solar panels, solar pumps, inverters and solar equipment and the manufacturer of gel batteries, led lighting products and solar furniture.

Besides these products, it is one of the first names coming to mind in the sector in the fields of project consultancy, energy application and energy systems installation commitment.

With the experience gained, it took the first step in 2015 in the direction of manufacturing and started R&D works to make the lighting luminaries a compact structure.

By incorporating the production of solar panels in the last quarter of 2017, it could be able to combine solar panel technology with Lighting Luminaries in a compact structure. Currently, it has got the personnel and equipment capable of serial production with its 1000 m<sup>2</sup> production line. It takes firm steps with the principle of "Future is of Light."



# X NEVA LIGHT











## LSA 20

### Teknik Özellikler / Technical Specifications

Lamba Boyutu / Lamp Dimensions	455X180X70mm
Solar Panel / Solar Panel	6V / 5Wp 1A Mono Cystal
Solar Panel / Solar Panel Dimensions	170X350 mm
Kurulum Yüksekliği / Installation Height	2-3 m
Sarj Süresi / Charge Time	6-8 Saat/Hour
Kontrol Sistemi / Control System	Işık ve Hareket Sensörü Light Sensor, Motion Sensor
Pil / Battery	3.7V / 6600mAH Li-ion
LED / LED	5630 Power LG Chip LED
Lumen / Lumen	800
Koruma Sınıfı / IP Degree	IP 65
Çalışma Süresi / Operation Time	12 Saat/Hour
Sensör Mesafesi / Sensor Distance	8 m
Çalışma Sıcaklığı / Operation Temp	(-25°C) - (75°C)
Gövde / Body	ABS - Polycarbon - Alüminyum

### Radiation Characteristics

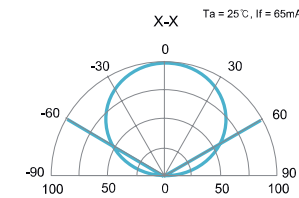

### LG Innotek

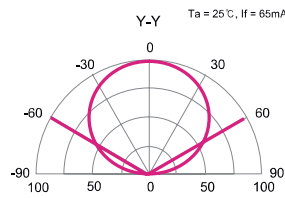

### Chromaticity Bins (Continued)

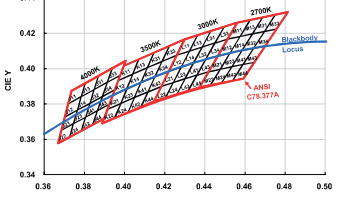

Discover  
the potential



**Akıllı Algılama**  
*Intelligent Detection*

**Hareket Algılandığında Maksimum Işık Etkileşir.**  
*Bright light activates when sensing motion.*





Discover  
the potential



## LSA 40

### Teknik Özellikler / Technical Specifications

Lamba Boyutu / Lamp Dimensions	455X180X70mm
Solar Panel / Solar Panel	6V / 9Wp 1.3A Mono Crystall
Solar Panel / Solar Panel Dimensions	170X350 mm
Kurulum Yüksekliği / Installation Height	3-4 m
Sarj Süresi / Charge Time	6-8 Saat/Hour
Kontrol Sistemi / Control System	Işık ve Hareket Sensörü Light Sensor, Motion Sensor
Pil / Battery	3.7V / 880mAH Li-ion
LED / LED	5630 Power LG Chip LED
Lumen / Lumen	1400
Koruma Sınıfı / IP Degree	IP 65
Çalışma Süresi / Operation Time	12 Saat/Hour
Sensör Mesafesi / Sensor Distance	8 m
Çalışma Sıcaklığı / Operation Temp	(-25°C) - (75°C)
Gövde / Body	ABS - Polycarbon - Alüminyum

### Radiation Characteristics

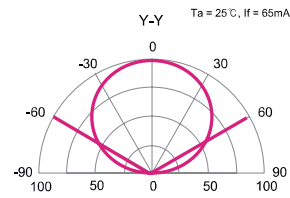
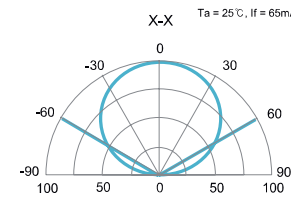

### Chromaticity Bins (Continued)

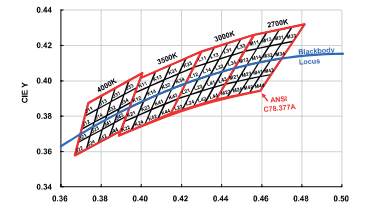

**Akıllı Algılama**  
*Intelligent Detection*

**Hareket Algılandığında Maksimum Işık Etkileşir.**  
*Bright light activates when sensing motion.*



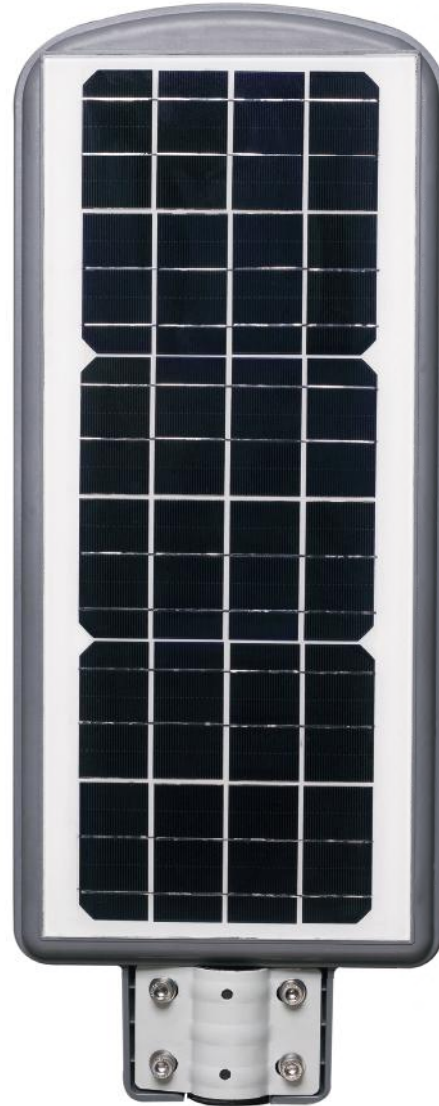

**LED**  
Discover  
the potential



## LSA 60

### Teknik Özellikler / Technical Specifications

Lamba Boyutu / Lamp Dimensions	635X250X70mm
Solar Panel / Solar Panel	12V / 16Wp 1.3A Mono Crystall
Solar Panel / Solar Panel Dimensions	620X250 mm
Kurulum Yüksekliği / Installation Height	4 m
Sarj Süresi / Charge Time	6-8 Saat/Hour
Pil / Battery	7.4V / 1100mAH Li-ion
Kontrol Sistemi / Control System	Işık ve Hareket Sensörü Light Sensor, Motion Sensor
LED / LED	5630 Power LG Chip LED
Lumen / Lumen	1800
Koruma Sınıfı / IP Degree	IP 65
Çalışma Süresi / Operation Time	12 Saat/Hour
Sensör Mesafesi / Sensor Distance	8 m
Çalışma Sıcaklığı / Operation Temp	(-25°C) - (75°C)
Gövde / Body	ABS - Polycarbon - Alüminyum

### Radiation Characteristics

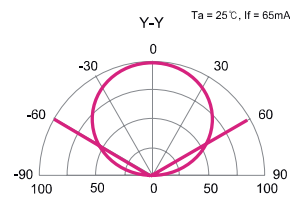
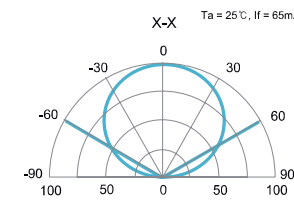

### Chromaticity Bins (Continued)

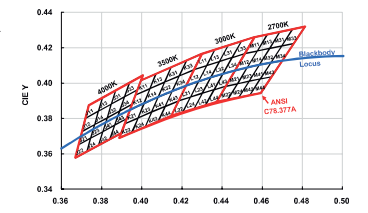

### Akıllı Algılama

*Intelligent Detection*

**Hareket Algılandığında Maksimum Işık Etkileşir.**

*Bright light activates when sensing motion.*





## LSA 80

### Teknik Özellikler / Technical Specifications

Lamba Boyutu / Lamp Dimensions	523X325 X 75mm
Solar Panel / Solar Panel	15V / 28Wp / 1,9A Mono Cystal
Solar Panel / Solar Panel Dimensions	513 X 315mm
Kurulum Yüksekliği / Installation Height	4-5 m
Sarj Süresi / Charge Time	6-8 Saat/Hour
Pil / Battery	9.6V / 12.000mAH LifePo4
Kontrol Sistemi / Control System	Işık ve Hareket Sensörü Light Sensor, Motion Sensor
LED / LED	5630 Power LG Chip LED
Lumen / Lumen	2300 MAX
Koruma Sınıfı / IP Degree	IP 65
Çalışma Süresi / Operation Time	12 Saat/Hour
Sensör Mesafesi / Sensor Distance	12 m
Çalışma Sıcaklığı / Operation Temp	(-25°C) - (75°C)
Gövde / Body	Polycarbon

### Radiation Characteristics

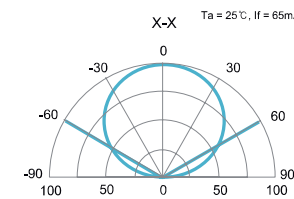

### LG Innotek

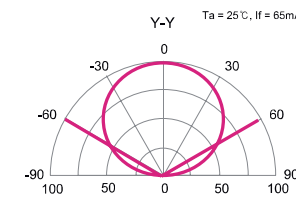

### Chromaticity Bins (Continued)

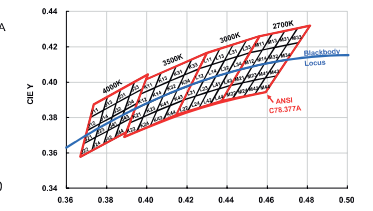

**Akıllı Algılama**  
*Intelligent Detection*

**Hareket Algılandığında Maksimum Işık Etkileşir.**  
*Bright light activates when sensing motion.*







## LSA 90

### Teknik Özellikler / Technical Specifications

Lamba Boyutu / Lamp Dimensions	730X430X70mm
Solar Panel / Solar Panel	12V / 3.80A / 44.6W Mono Crystall
Solar Panel / Solar Panel Dimensions	720X420X4 mm
Kurulum Yüksekliği / Installation Height	5-6 m
Sarj Süresi / Charge Time	6-8 Saat/Hour
Pil / Battery	9.6V / 12000mAh LifePo4
Kontrol Sistemi / Control System	Işık ve Hareket Sensörü Light Sensor, Motion Sensor
LED / LED	5630 Power LG Chip LED
Lumen / Lumen	3000 MAX
Koruma Sınıfı / IP Degree	IP 65
Çalışma Süresi / Operation Time	12 Saat/Hour
Sensör Mesafesi / Sensor Distance	12 m
Çalışma Sıcaklığı / Operation Temp	(-25°C) - (75°C)
Gövde / Body	Polycarbon

### Radiation Characteristics

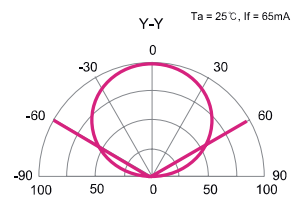
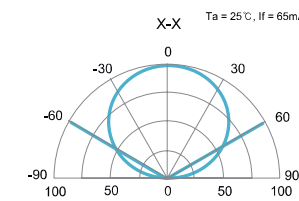

### Chromaticity Bins (Continued)

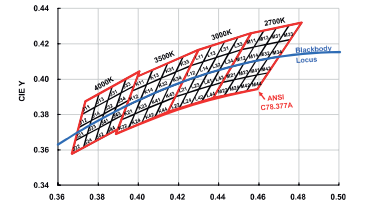

Discover  
the potential



**Akıllı Algılama**  
*Intelligent Detection*

**Hareket Algılandığında Maksimum Işık Etkileşir.**  
*Bright light activates when sensing motion.*



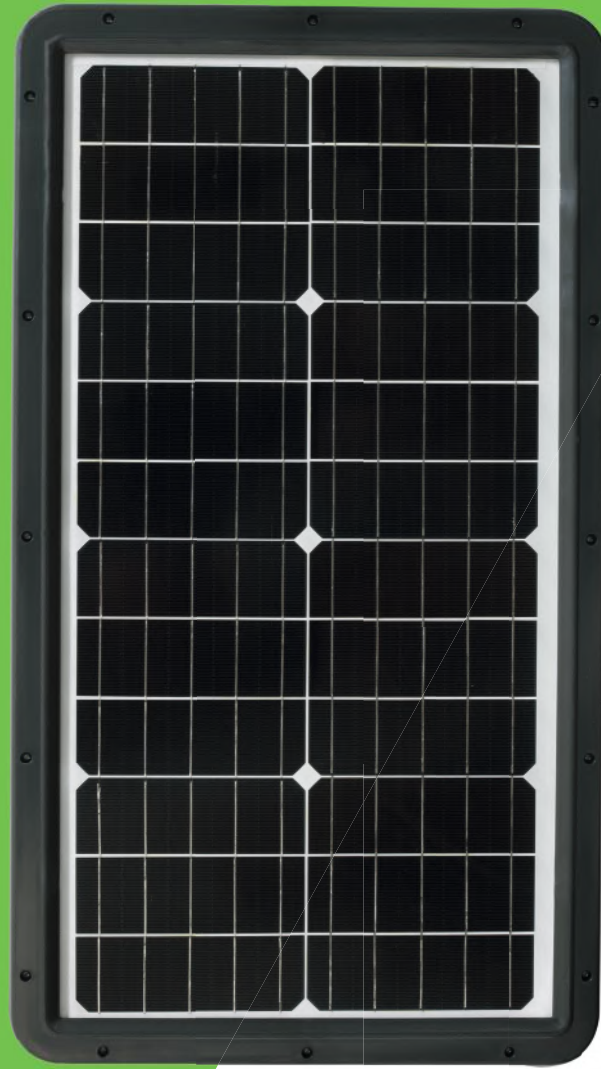

## LSA 100

### Teknik Özellikler / Technical Specifications

Lamba Boyutu / Lamp Dimensions	730X430X70mm
Solar Panel / Solar Panel	12V / 3.80A / 44.6W Mono Crystall
Solar Panel / Solar Panel Dimensions	720X420X4 mm
Kurulum Yüksekliği / Installation Height	5-6 m
Sarj Süresi / Charge Time	6-8 Saat/Hour
Pil / Battery	9.6V / 18000mAh LifePo4
Kontrol Sistemi / Control System	6 Saat Max / 6 Saat DIM Modu Max 6 Hour / DIM Mod 6 Hour
LED / LED	5630 Power LG Chip LED
Lumen / Lumen	3000 MAX
Koruma Sınıfı / IP Degree	IP 65
Çalışma Süresi / Operation Time	12 Saat/Hour
Sensör Mesafesi / Sensor Distance	12 m
Çalışma Sıcaklığı / Operation Temp	(-25°C) - (75°C)
Gövde / Body	Polycarbon

### Radiation Characteristics

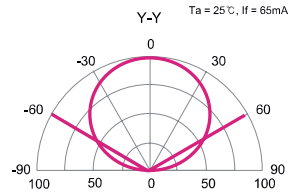
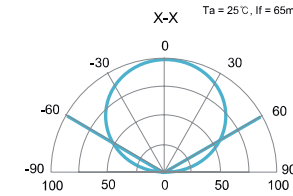

### Chromaticity Bins (Continued)

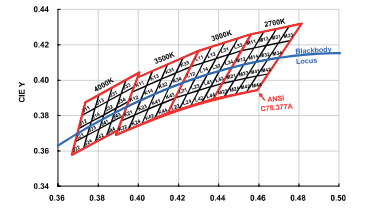

**6 Saat %100 Tam Kapasite İle Çalışır.**  
*Works at 100% full capacity for 6 hours*

**Sonra%50 Işığı Azaltarak Çalışır.**  
*Then it works by reducing 50% light*



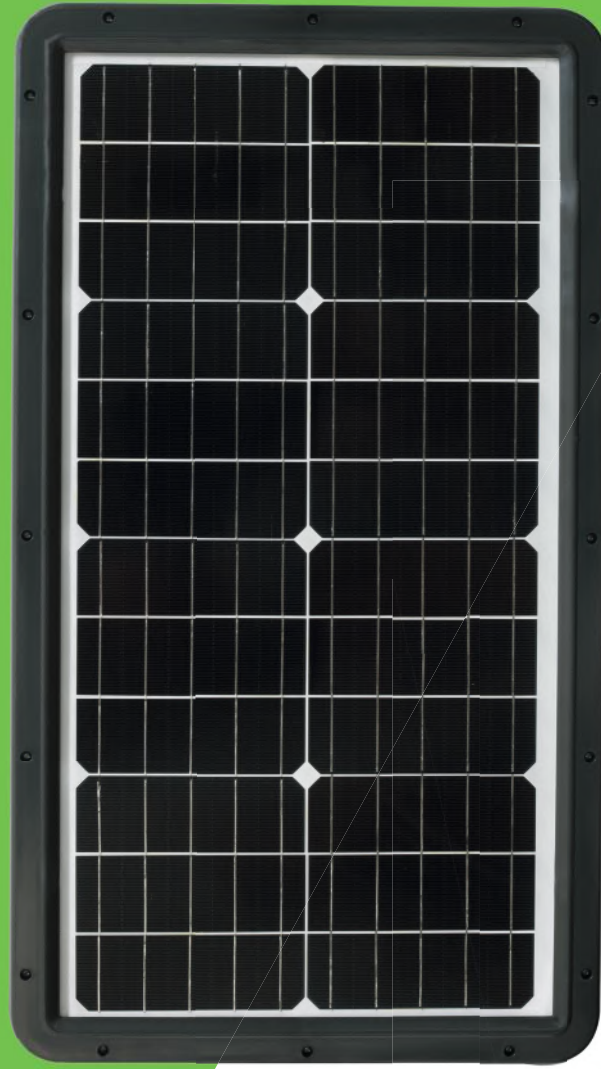

## LSA 120

### Teknik Özellikler / Technical Specifications

Lamba Boyutu / Lamp Dimensions	730X430X70mm
Solar Panel / Solar Panel	12V / 3.80A / 44.6W
Solar Panel / Solar Panel Dimensions	720X420X4 mm
Kurulum Yüksekliği / Installation Height	6-7 mm
Sarj Süresi / Charge Time	6-8 Saat/Hour
Pil / Battery	9.6V / 18000mAh LifePo4
Kontrol Sistemi / Control System	Işık ve Hareket Sensörü Light Sensor, Motion Sensor
LED / LED	5630 Power LG Chip LED
Lumen / Lumen	5500 MAX
Koruma Sınıfı / IP Degree	IP 65
Çalışma Süresi / Operation Time	12 Saat/Hour
Sensör Mesafesi / Sensor Distance	12 m
Çalışma Sıcaklığı / Operation Temp	(-25°C) - (75°C)
Gövde / Body	Polycarbon

### Radiation Characteristics

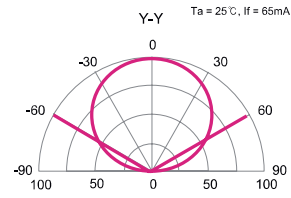
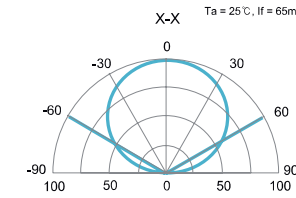

### Chromaticity Bins (Continued)

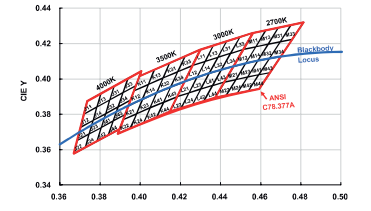

Discover  
the potential



**Akıllı Algılama**  
*Intelligent Detection*

**Hareket Algılandığında Maksimum Işık Etkileşir.**  
*Bright light activates when sensing motion.*





## LSA 150

### Teknik Özellikler / Technical Specifications

Lamba Boyutu / Lamp Dimensions	1025X410X197mm
Solar Panel / Solar Panel	18V/65Wp/3,6A Mono Crystall
Solar Panel / Solar Panel Dimensions	1000X360 mm
Kurulum Yüksekliği / Installation Height	7-8 m
Sarj Süresi / Charge Time	6-8 Saat/Hour
Pil / Battery	308Kw/h Lithium Iron Phosphate LifePo4
Kontrol Sistemi / Control System	Işık ve Hareket Sensörü Light Sensor, Motion Sensor
LED / LED	5630 Power LG Chip LED
Lumen / Lumen	8000 MAX
Koruma Sınıfı / IP Degree	IP 65
Çalışma Süresi / Operation Time	12 Saat/Hour
Sensör Mesafesi / Sensor Distance	12 m
Çalışma Sıcaklığı / Operation Temp	(-25°C) - (75°C)
Gövde / Body	Aluminyum/Polycarbon/GFR30

### Radiation Characteristics

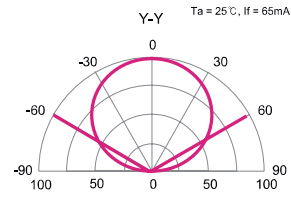
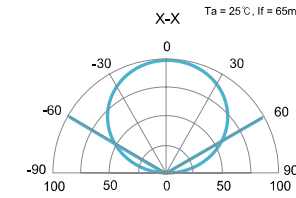

### Chromaticity Bins (Continued)

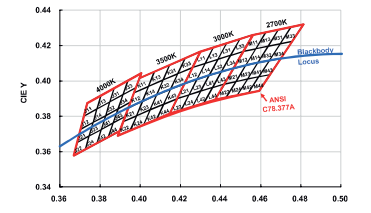

**Akıllı Algılama**  
*Intelligent Detection*

**Hareket Algılandığında Maksimum Işık Etkileşir.**  
*Bright light activates when sensing motion.*







## LSA 180

### Teknik Özellikler / Technical Specifications

Lamba Boyutu / Lamp Dimensions	1526 X 401 X 204mm
Solar Panel / Solar Panel	18V / 100Wp/3,6A Mono Crystall
Solar Panel / Solar Panel Dimensions	1500 X 360 mm
Kurulum Yüksekliği / Installation Height	8-10 m
Sarj Süresi / Charge Time	6-8 Saat/Hour
Pil / Battery	462Kwh Lithium Iron Phosphate LifePo4
Kontrol Sistemi / Control System	Işık ve Hareket Sensörü Light Sensor, Motion Sensor
LED / LED	5630 Power LG Chip LED
Lumen / Lumen	10.000 MAX
Koruma Sınıfı / IP Degree	IP 65
Çalışma Süresi / Operation Time	12 Saat/Hour
Sensör Mesafesi / Sensor Distance	12 m
Çalışma Sıcaklığı / Operation Temp	(-25°C) - (75°C)
Gövde / Body	Aluminyum/Polycarbon/GFR30

### Radiation Characteristics

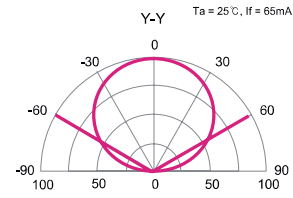
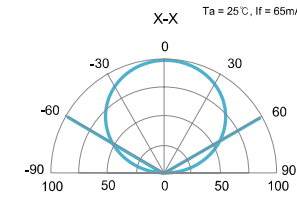

### Chromaticity Bins (Continued)

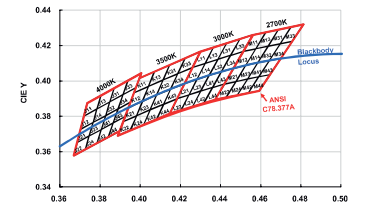

## Akıllı Algılama Intelligent Detection







Discover  
the potential



## LSA 200

### Teknik Özellikler / Technical Specifications

Lamba Boyutu / Lamp Dimensions	2026 X 401 X 204mm
Solar Panel / Solar Panel	18V/134Wp/3,6A Mono Crystall
Solar Panel / Solar Panel Dimensions	2000 X 360 mm
Kurulum Yüksekliği / Installation Height	10-12 m
Sarj Süresi / Charge Time	6-8 Saat/Hour
Pil / Battery	616Kwh Lithium Iron Phosphate LifePo4
Kontrol Sistemi / Control System	Işık ve Hareket Sensörü Light Sensor, Motion Sensor
LED / LED	5630 Power LG Chip LED
Lumen / Lumen	12.000 MAX
Koruma Sınıfı / IP Degree	IP 65
Çalışma Süresi / Operation Time	12 Saat/Hour
Sensör Mesafesi / Sensor Distance	12 m
Çalışma Sıcaklığı / Operation Temp	(-25°C) - (75°C)
Gövde / Body	Aluminyum/Polycarbon/GFR30

### Radiation Characteristics

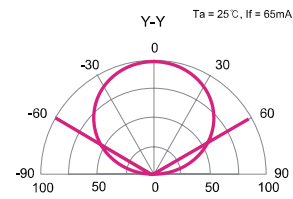
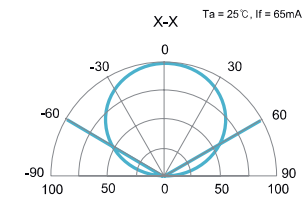

### Chromaticity Bins (Continued)

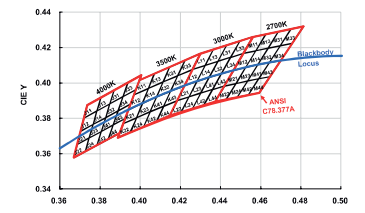

**Akıllı Algılama**  
*Intelligent Detection*





## LSE 2500

### Teknik Özellikler / Technical Specifications

Lamba Boyutu / Lamp Dimensions	741X874mm
Solar Panel / Solar Panel	12V / 3.80A / 44.6W Mono Crystall
Solar Panel / Solar Panel Dimensions	750X750X4 mm
Kurulum Yüksekliği / Installation Height	3-5 m
Sarj Süresi / Charge Time	6-8 Saat/Hour
Pil / Battery	172 Kw/h / Lithium Iron Phosphate LifePo4
Kontrol Sistemi / Control System	6 Saat Max / 6 Saat DIM Modu Max 6 Hour / DIM Mod 6 Hour
LED / LED	5630 Power LG Chip LED
Lumen / Lumen	3000 MAX
Koruma Sınıfı / IP Degree	IP 65
Çalışma Süresi / Operation Time	12 Saat/Hour
Çalışma Sıcaklığı / Operation Temp	(-25°C) - (75°C)
Gövde / Body	Polycarbon

### Radiation Characteristics

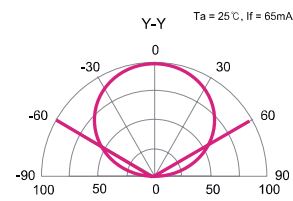
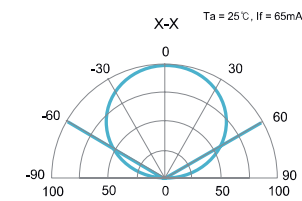

### Chromaticity Bins (Continued)

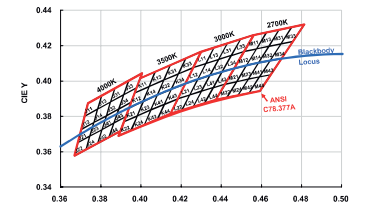

Discover  
the potential



**6 Saat %100 Tam Kapasite ile Çalışır.**  
Works at 100% full capacity for 6 hours

**Sonra%50 Işığı Azaltarak Çalışır.**  
Then it works by reducing 50% light





Discover  
the potential



## LP 1000

### Teknik Özellikler / Technical Specifications

Lamba Boyutu / Lamp Dimensions	125X165X95mm
Solar Panel / Solar Panel	12V /16Wp 1.3A Mono Crystall
Solar Panel / Solar Panel Dimensions	620X250 mm
Kurulum Yüksekliği / Installation Height	5 m
Sarj Süresi / Charge Time	6-8 Saat/Hour
Pil / Battery	7.4V / 1100mAH Li-ion
LED / LED	5630 Power LG Chip LED
Lumen / Lumen	1000
Koruma Sınıfı / IP Degree	IP 67
Çalışma Süresi / Operation Time	6 Saat Max / 6 Saat DIM Modu Max 6 Hour / DIM Mod 6 Hour
Çalışma Sıcaklığı / Operation Temp	(-25°C) - (75°C)
Gövde / Body	ABS - Polycarbon - Alüminyum

### Radiation Characteristics

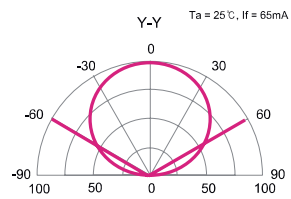
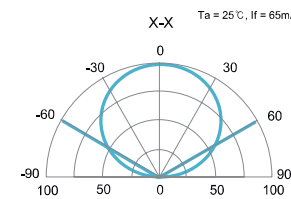

### Chromaticity Bins (Continued)

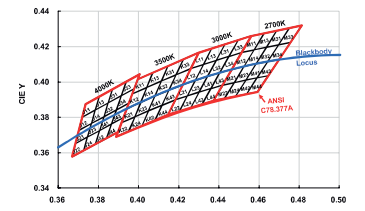

**6 Saat %100 Tam Kapasite İle Çalışır.**

*Works at 100% full capacity for 6 hours*

**Sonra%50 Işığı Azaltarak Çalışır.**

*Then it works by reducing 50% light*

**"ENERJİYE DAİR  
NE VARSA"**

**X NEVA  
LIGHT**

**X NEVA  
PARK**

**X NEVA  
TRAFFIC**

**X NEVA  
SOLAR**



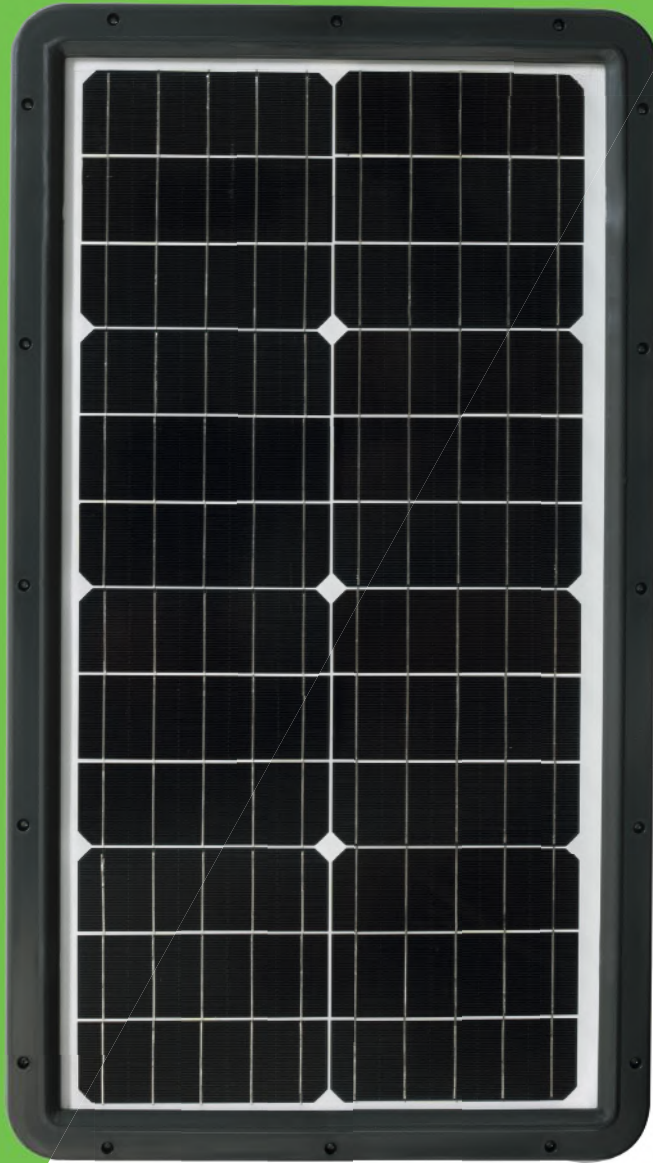

Discover  
the potential



## LP 2000

### Teknik Özellikler / Technical Specifications

Lamba Boyutu / Lamp Dimensions	325X165X95mm
Solar Panel / Solar Panel	12V / 3.80A / 44.6W Mono Crystall
Solar Panel / Solar Panel Dimensions	730x430x70mm
Kurulum Yüksekliği / Installation Height	5 m
Sarj Süresi / Charge Time	6-8 Saat/Hour
Pil / Battery	7.4V / 22.000mAH Li-ion
LED / LED	5630 Power LG Chip LED
Lumen / Lumen	2000
Koruma Sınıfı / IP Degree	IP 67
Çalışma Süresi / Operation Time	6 Saat Max / 6 Saat DIM Modu Max 6 Hour / DIM Mod 6 Hour
Çalışma Sıcaklığı / Operation Temp	(-25°C) - (75°C)
Gövde / Body	ABS - Polycarbon - Alüminyum

### Radiation Characteristics

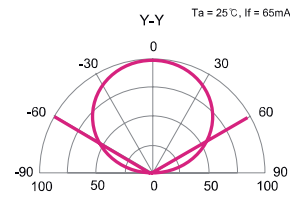
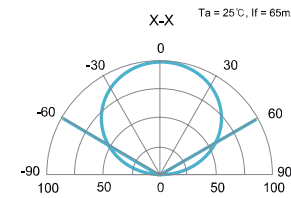

### Chromaticity Bins (Continued)

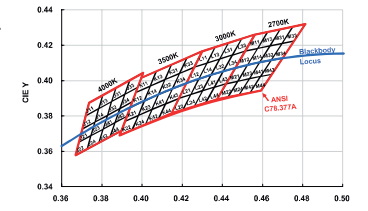

**6 Saat %100 Tam Kapasite İle Çalışır.**

*Works at 100% full capacity for 6 hours*

**Sonra%50 Işığı Azaltarak Çalışır.**

*Then it works by reducing 50% light*





## LSD 2000

### Teknik Özellikler / Technical Specifications

Lamba Boyutu / Lamp Dimensions	730x430x70mm
Solar Panel / Solar Panel	12V /44.6Wp/3,8A Mono Crystall
Solar Panel / Solar Panel Dimensions	720x420x4mm
Kurulum Yüksekliği / Installation Height	5 m
Sarj Süresi / Charge Time	6-8 Saat/Hour
Pil / Battery	7.4V / 22.000mAH Li-ion
LED / LED	5630 Power LG Chip LED
Lumen / Lumen	2000 MAX
Koruma Sınıfı / IP Degree	IP 67
Çalışma Süresi / Operation Time	6 Saat Max / 6 Saat DIM Modu Max 6 Hour / DIM Mod 6 Hour
Çalışma Sıcaklığı / Operation Temp	(-25°C) - (75°C)
Gövde / Body	ABS - Polycarbon - Alüminyum

### Radiation Characteristics

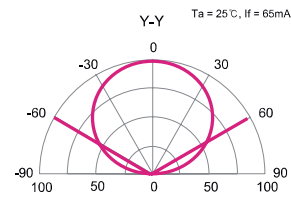
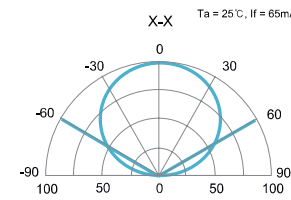

### Chromaticity Bins (Continued)

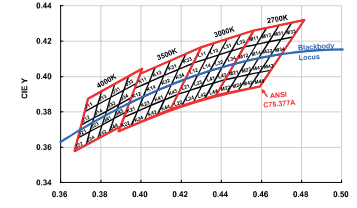

**Discover the potential**



**6 Saat %100 Tam Kapasite ile Çalışır.**  
Works at 100% full capacity for 6 hours

**Sonra%50 Işığı Azaltarak Çalışır.**  
Then it works by reducing 50% light





Discover  
the potential



## USL 1100

### Teknik Özellikler / Technical Specifications

Lamba Boyutu / Lamp Dimensions	190x130x190mm
Solar Panel / Solar Panel	12V / 1.45A / 17Wp
Solar Panel / Solar Panel Dimensions	610x350mm
USB Port / USB Port	2X1 Ah
Sarj Süresi / Charge Time	6-8 Saat/Hour
Pil / Battery	7.4V / 11000mAh Li-ion
Kontrol Sistemi / Control System	6 Saat Max / 6 Saat DIM Modu Max 6 Hour / DIM Mod 6 Hour
LED / LED	5630 Power LG Chip LED
Lumen / Lumen	500 MAX
Koruma Sınıfı / IP Degree	IP 65
Çalışma Süresi / Operation Time	12 Saat/Hour
Sensör Mesafesi / Sensor Distance	12 m
Çalışma Sıcaklığı / Operation Temp	(-25°C) - (75°C)
Gövde / Body	Metal - ABS
Kablo Boyu / Cable Dimensions	5 m

### Radiation Characteristics

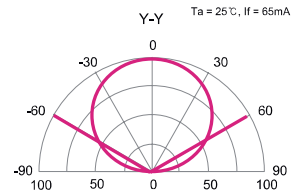
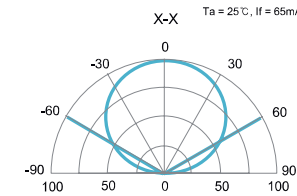

### Chromaticity Bins (Continued)

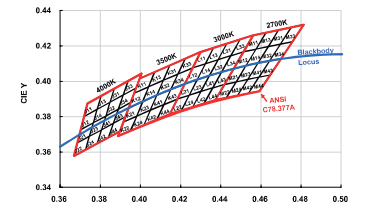

**Taşınabilir Güç Kutusu**  
Portable power box

**Aydınlatma ve USB Sarj Cihazı**  
Lighting and USB charger





## NVB 100

### Teknik Özellikler / Technical Specifications

Lamba Boyutu / Lamp Dimensions	1000X180X60mm
Solar Panel / Solar Panel	6V/12Wp 1.8A Mono Crystal
Solar Panel / Solar Panel Dimensions	170X350mm
Sarj Süresi / Charge Time	6-8 Saat/Hour
Pil / Battery	3.7V/12000mAh Li-On
LED / LED	5630 Power LG Chip LED
Lumen / Lumen	2 X 600
Koruma Sınıfı / IP Degree	IP 65
Çalışma Süresi / Operation Time	12 Saat/Hour
Çalışma Sıcaklığı / Operation Temp	(-25°C) - (75°C)
Gövde / Body	1 mm Sac + Statik Boya
Montaj / Install	Ankraj dahil

### Radiation Characteristics

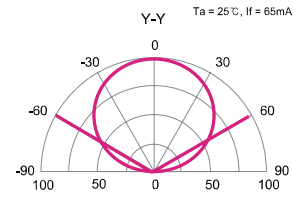
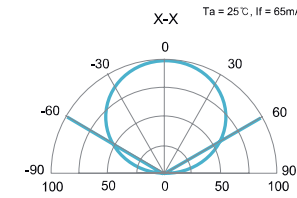

### Chromaticity Bins (Continued)

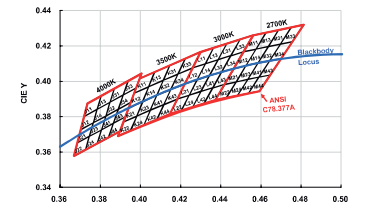

Discover  
the potential









## NVB 150

### Teknik Özellikler / Technical Specifications

Lamba Boyutu / Lamp Dimensions	1500X180X60mm
Solar Panel / Solar Panel	6V/12Wp 1.8A Mono Crystal
Solar Panel / Solar Panel Dimensions	170X350mm
Sarj Süresi / Charge Time	6-8 Saat/Hour
Pil / Battery	3.7V/12000mAh Li-On
LED / LED	5630 Power LG Chip LED
Lumen / Lumen	2 X 600
Koruma Sınıfı / IP Degree	IP 65
Çalışma Süresi / Operation Time	12 Saat/Hour
Çalışma Sıcaklığı / Operation Temp	(-25°C) - (75°C)
Gövde / Body	1 mm Sac + Statik Boya
Montaj / Install	Ankraj dahil

### Radiation Characteristics

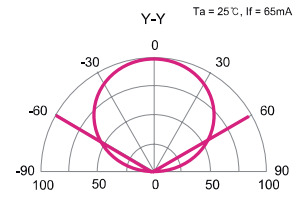
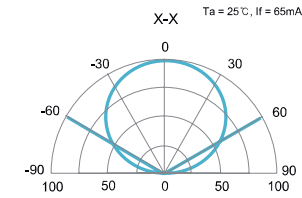

### Chromaticity Bins (Continued)

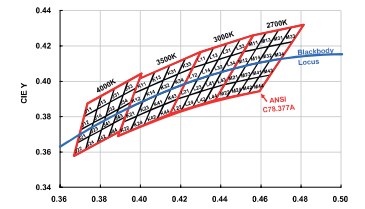

Discover  
the potential







Discover  
the potential



## LSW 20

### Teknik Özellikler / Technical Specifications

Lamba Boyutu / Lamp Dimensions	225X225X155mm
Solar Panel / Solar Panel	5 V / 250mA / Mono Cyrstall
Solar Panel / Solar Panel Dimensions	110X110 mm
Kurulum Yüksekliği / Installation Height	2-3 mm
Sarj Süresi / Charge Time	6-8 Saat/Hour
Pil / Battery	3.7V / 2200mAH Li-ion
Kontrol Sistemi / Control System	Işık ve Hareket Sensörü Light Sensor, Motion Sensor
LED / LED	5630 Power LG Chip LED
Lumen / Lumen	500 MAX
Koruma Sınıfı / IP Degree	IP 65
Çalışma Süresi / Operation Time	12 Saat/Hour
Sensör Mesafesi / Sensor Distance	8 m
Çalışma Sıcaklığı / Operation Temp	(-25°C) - (75°C)
Gövde / Body	ABS - Polycarbon

### Radiation Characteristics

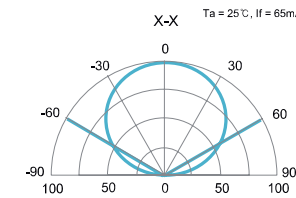

### LG Innotek

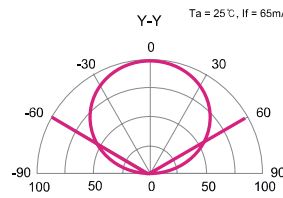

### Chromaticity Bins (Continued)

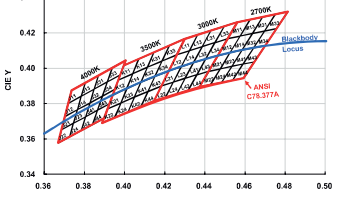

**Akıllı Algılama**  
*Intelligent Detection*

**Hareket Algılandığında Maksimum Işık Etkileşir.**  
*Bright light activates when sensing motion.*



## SET ÜSTÜ APLİKLER / SET-TOP APPLIQUES



NVL 101



NVL 102



NVL 103

### NVL 101-102-103

#### Teknik Özellikler / Technical Specifications

Ebatlar / Dimensions	400X300 mm
Materyal / Materiel	ABS PVC
Solar Panel Ölçüsü / Solar Panel Dimensions	225X225 mm
Solar Panel / Solar Panel	9 Wp / 12.5V / 700mA
Batarya / Battery	7.4V/4400mA Li-ion
LED Işık Gücü / LED Light Power	6W / 450 Lümen
LED / LED	LG 5630 Mid Power
Montaj / Assembly	4 Adet Dübel
Çalışma / Operation	Karanlıkta Otomatik



## KISA KOL DUVAR APLİKLER / SHORT ARM WALL APPLIQUES



NVL 104



NVL 105



NVL 106

### NVL 104-105-106

#### Teknik Özellikler / Technical Specifications

Ebatlar / Dimensions	400X300X600 mm
Materyal / Materiel	ABS PVC
Solar Panel Ölçüsü / Solar Panel Dimensions	225X225 mm
Solar Panel / Solar Panel	9 Wp / 12.5V / 700mA
Batarya / Battery	7.4V/4400mA Li-ion
LED Işık Gücü / LED Light Power	6W / 450 Lümen
LED / LED	LG 5630 Mid Power
Montaj / Assembly	4 Adet Dübel
Çalışma / Operation	Karanlıkta Otomatik





## UZUN KOL SUVAR APLİKLER / LONG ARM WALL APPLIQUES



NVL 107



NVL 108



NVL 109

### NVL 107-108-109

#### Teknik Özellikler / Technical Specifications

Ebatlar / Dimensions	400X300X600 mm
Materyal / Materiel	ABS PVC
Solar Panel Ölçüsü / Solar Panel Dimensions	225X225 mm
Solar Panel / Solar Panel	9 Wp / 12.5V / 700mA
Batarya / Battery	7.4V/4400mA Li-ion
LED Işık Gücü / LED Light Power	6W / 450 Lümen
LED / LED	LG 5630 Mid Power
Montaj / Assembly	4 Adet Dübel
Çalışma / Operation	Karanlıkta Otomatik



## 100 CM BOLLARD APLİKLER / 100 CM BOLLARD APPLIQUES



NVL 110



NVL 111



NVL 112

### NVL 110-111-112

#### Teknik Özellikler / Technical Specifications

Ebatlar / Dimensions	440X1000 mm
Materyal / Materiel	ABS PVC
Solar Panel Ölçüsü / Solar Panel Dimensions	225X225 mm
Solar Panel / Solar Panel	9 Wp / 12.5V / 700mA
Batarya / Battery	7.4V/4400mA Li-ion
LED Işık Gücü / LED Light Power	6W / 450 Lümen
LED / LED	LG 5630 Mid Power
Montaj / Assembly	Ankraj Seti
Çalışma / Operation	Karanlıkta Otomatik



## 150 CM BOLLARD APLİKLER / 150 CM BOLLARD APPLIQUES



NVL 113



NVL 115



NVL 114

### NVL 113-114-115

#### Teknik Özellikler / Technical Specifications

Ebatlar / Dimensions	440X1500 mm
Materyal / Materiel	ABS PVC
Solar Panel Ölçüsü / Solar Panel Dimensions	225X225 mm
Solar Panel / Solar Panel	9 Wp / 12.5V / 700mA
Batarya / Battery	7.4V/4400mA Li-ion
LED Işık Gücü / LED Light Power	6W / 450 Lümen
LED / LED	LG 5630 Mid Power
Montaj / Assembly	Ankraj Seti
Çalışma / Operation	Karanlıkta Otomatik



## 300 CM BOLLARD APLİKLER / 300 CM BOLLARD APPLIQUES



NVL 116



NVL 118



NVL 117

### NVL 116-117-118

#### Teknik Özellikler / Technical Specifications

Ebatlar / Dimensions	440X3000 mm
Materyal / Materiel	ABS PVC
Solar Panel Ölçüsü / Solar Panel Dimensions	225X225 mm
Solar Panel / Solar Panel	2x9 Wp / 12.5V / 700mA
Batarya / Battery	2x7.4V/4400mA Li-ion
LED Işık Gücü / LED Light Power	2x6W / 450 Lümen
LED / LED	LG 5630 Mid Power
Montaj / Assembly	Ankraj Seti
Çalışma / Operation	Karanlıkta Otomatik







NEVA LIGHT

NEVA PARK

NEVA TRAFİK

NEVA SOLAR

# X NEVA PARK







### Soğuk Beyaz

Giriş Gerilimi	100-240 V
Frekans	
Tüketim	85 watt
Işık Şiddeti	9900 Lümen
Çalışma Sıcaklığı	30°
LED Ömrü	50.000 Saat

### NVP 0003

#### Teknik Özellikler / Technical Specifications

Fener / Lattern	Led
Glop / Diffuse Dia	30 cm
Malzeme / Material	76x3 mm Metal Boru Üstü Desenli Plastik Kaplama 76x3 mm Metal Pipe The patterned Plastic Coating On Top
Taban / Base	Plastik Plastic
Ölçüler / Dimensions	En: 270 cm Boy: 470 / 570 cm



### Soğuk Beyaz

Giriş Gerilimi	100-240 V
Frekans	
Tüketim	85 watt
Işık Şiddeti	9900 Lümen
Çalışma Sıcaklığı	30° / +70°
LED Ömrü	50.000 Saat

### NVP 0004

#### Teknik Özellikler / Technical Specifications

Fener / Lattern	Led
Glop / Diffuse Dia	30 cm
Malzeme / Material	76x3 mm Metal Boru Üstü Desenli Plastik Kaplama ve Metal İsteğe Göre 76x3 mm Metal Pipe The patterned Plastic Coating On Top and Metal on Request
Taban / Base	Pik Döküm Iron Cast
Ölçüler / Dimensions	En: 110 cm Boy: 370/470 cm

## NVP 0018

### Teknik Özellikler / Technical Specifications

Fener / Lattern	Plastik Plastic
Glop / Diffuse Dia	30 cm
Malzeme / Material	Plastik Plastic
Taban / Base	Plastik Plastic
Ölçüler / Dimensions	En: 30 cm Boy: 50 cm



## NVP 0019

### Teknik Özellikler / Technical Specifications

Fener / Lattern	Plastik Plastic
Glop / Diffuse Dia	30 cm
Malzeme / Material	Plastik Plastic
Ölçüler / Dimensions	En: 30 cm Boy: 50 cm



## NVP 0020

### Teknik Özellikler / Technical Specifications

Fener / Lattern	Plastik Plastic
Glop / Diffuse Dia	30 cm
Malzeme / Material	Plastik Plastic
Ölçüler / Dimensions	En: 40 cm Boy: 65 cm

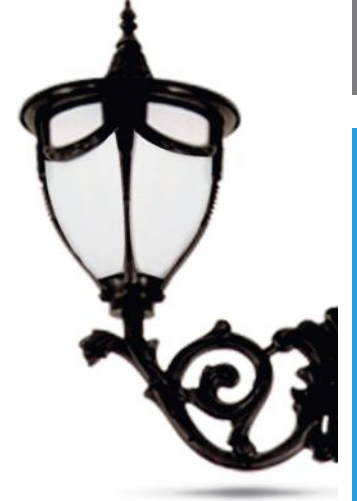

## NVP 0024

### Teknik Özellikler / Technical Specifications

Fener / Lattern	Plastik Plastic
Glop / Diffuse Dia	30 cm
Malzeme / Material	48x3 mm Metal Boru Üstü Desenli Plastik Kaplama 48x3 mm Metal Pipe The patterned Plastic Coating On Top
Taban / Base	Plastik Plastic
Ölçüler / Dimensions	En: 70 cm Boy: 120 cm



## NVP 0028

### Teknik Özellikler / Technical Specifications

Fener / Lattern	Plastik Plastic
Glop / Diffuse Dia	30 cm
Malzeme / Material	48x3 mm Metal Boru Üstü Desenli Plastik Kaplama 48x3 mm Metal Pipe The patterned Plastic Coating On Top
Taban / Base	Plastik Plastic
Ölçüler / Dimensions	En: 90 cm Boy: 275 cm



## NVP 0029

### Teknik Özellikler / Technical Specifications

Fener / Lattern	Plastik Plastic
Glop / Diffuse Dia	24 cm
Malzeme / Material	Plastik Plastic
Ölçüler / Dimensions	En: 24 cm Boy: 55 cm



## NVP 0031

### Teknik Özellikler / Technical Specifications

Fener / Lattern	Plastik Plastic
Glop / Diffuse Dia	24 cm
Malzeme / Material	Plastik Plastic
Ölçüler / Dimensions	En: 24 cm Boy: 55 cm



## NVP 0032

### Teknik Özellikler / Technical Specifications

Fener / Lattern	Plastik Plastic
Glop / Diffuse Dia	24 cm
Malzeme / Material	Plastik Plastic
Ölçüler / Dimensions	En: 24 cm Boy: 65 cm



## NVP 0037

### Teknik Özellikler / Technical Specifications

Fener / Lattern	Plastik Plastic
Glop / Diffuse Dia	24 cm
Malzeme / Material	48x3 mm Metal Boru Üstü Desenli Plastik Kaplama 48x3 mm Metal Pipe The patterned Plastic Coating On Top
Taban / Base	Plastik Plastic
Ölçüler / Dimensions	En: 45 cm Boy: 200 cm



## NVP 0039

### Teknik Özellikler / Technical Specifications

Fener / Lattern	Plastik Plastic
Glop / Diffuse Dia	24 cm
Malzeme / Material	48x3 mm Metal Boru Üstü Desenli Plastik Kaplama 48x3 mm Metal Pipe The patterned Plastic Coating On Top
Taban / Base	Plastik Plastic
Ölçüler / Dimensions	En: 90 cm Boy: 300 cm



## NVP 0042

### Teknik Özellikler / Technical Specifications

Fener / Lattern	Plastik Plastic
Glop / Diffuse Dia	20 cm
Malzeme / Material	Plastik Plastic
Taban / Base	Plastik Plastic
Ölçüler / Dimensions	En: 20 cm Boy: 40 cm



## NVP 0043

Teknik Özellikler / Technical Specifications	
Fener / Lattern	Plastik Plastic
Glop / Diffuse Dia	20 cm
Malzeme / Material	Plastik Plastic
Ölçüler / Dimensions	En: 20 cm Boy: 50 cm



## NVP 0044

Teknik Özellikler / Technical Specifications	
Fener / Lattern	Plastik Plastic
Glop / Diffuse Dia	20 cm
Malzeme / Material	Plastik Plastic
Taban / Base	Plastik Plastic
Ölçüler / Dimensions	En: 20 cm Boy: 65 cm



## NVP 0046

Teknik Özellikler / Technical Specifications	
Fener / Lattern	Plastik Plastic
Glop / Diffuse Dia	20 cm
Malzeme / Material	42x2 mm Metal Boru Üstü Desenli Plastik Kaplama 42x2 mm Metal Pipe The patterned Plastic Coating On Top
Taban / Base	Plastik Plastic
Ölçüler / Dimensions	En: 70 cm Boy: 110 cm



## NVP 0047

Teknik Özellikler / Technical Specifications	
Fener / Lattern	Plastik Plastic
Glop / Diffuse Dia	20 cm
Malzeme / Material	Plastik Plastic
Ölçüler / Dimensions	En: 35 cm Boy: 50 cm

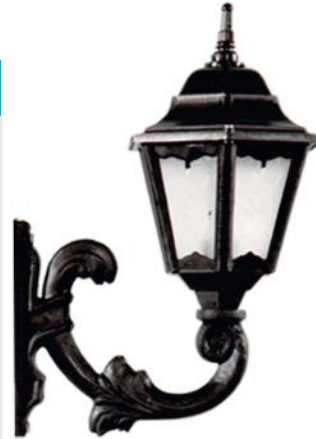

## NVP 0050

Teknik Özellikler / Technical Specifications	
Fener / Lattern	Plastik Plastic
Glop / Diffuse Dia	20 cm
Malzeme / Material	48x3 mm Metal Boru Üstü Desenli Plastik Kaplama 48x3 mm Metal Pipe The patterned Plastic Coating On Top
Taban / Base	Plastik Kaplama Plastic Coating
Ölçüler / Dimensions	En: 40 cm Boy: 240 cm



## NVP 0052

Teknik Özellikler / Technical Specifications	
Fener / Lattern	Plastik Plastic
Glop / Diffuse Dia	20 cm
Malzeme / Material	48x3 mm Metal Boru Üstü Desenli Plastik Kaplama 48x3 mm Metal Pipe The patterned Plastic Coating On Top
Taban / Base	Plastik Kaplama Plastic Coating
Ölçüler / Dimensions	En: 70 cm Boy: 300 cm



## NVP 0059

Teknik Özellikler / Technical Specifications	
Fener / Lattern	Plastik Plastic
Glop / Diffuse Dia	20 cm
Malzeme / Material	48x3 mm Metal Boru Üstü Desenli Plastik Kaplama 48x3 mm Metal Pipe The patterned Plastic Coating On Top
Taban / Base	Plastik Plastic
Ölçüler / Dimensions	En: 60 cm Boy: 280 cm



## NVP 0098

Teknik Özellikler / Technical Specifications	
Fener / Lattern	Plastik Plastic
Glop / Diffuse Dia	20 cm
Malzeme / Material	Plastik Plastic
Taban / Base	Plastik Plastic
Ölçüler / Dimensions	En: 20 cm Boy: 45 cm



## NVP 0099

Teknik Özellikler / Technical Specifications	
Fener / Lattern	Plastik Plastic
Glop / Diffuse Dia	20 cm
Malzeme / Material	Plastik Plastic
Ölçüler / Dimensions	En: 20 cm Boy: 50 cm



## NVP 0101

Teknik Özellikler / Technical Specifications	
Fener / Lattern	Plastik Plastic
Glop / Diffuse Dia	20 cm
Malzeme / Material	42x2 mm Metal Boru Üstü Desenli Plastik Kaplama 42x2 mm Metal Pipe The patterned Plastic Coating On Top
Taban / Base	Plastik Plastic
Ölçüler / Dimensions	En: 60 cm Boy: 120 cm



## NVP 0103

Teknik Özellikler / Technical Specifications	
Fener / Lattern	Plastik Plastic
Glop / Diffuse Dia	20 cm
Malzeme / Material	48x3 mm Metal Boru Üstü Desenli Plastik Kaplama 48x3 mm Metal Pipe The patterned Plastic Coating On Top
Taban / Base	Plastik Kaplama Plastic Coating
Ölçüler / Dimensions	En: 90 cm Boy: 300 cm



## NVP 0107

Teknik Özellikler / Technical Specifications	
Fener / Lattern	Plastik Plastic
Glop / Diffuse Dia	30 cm
Malzeme / Material	Plastik Plastic
Ölçüler / Dimensions	En: 45 cm Boy: 75 cm





**NVP 0110****Teknik Özellikler / Technical Specifications**

<b>Fener / Lattern</b>	Plastik Plastic
<b>Glop / Diffuse Dia</b>	30 cm
<b>Malzeme / Material</b>	48x3 mm Metal Boru Üstü Desenli Plastik Kaplama 48x3 mm Metal Pipe The patterned Plastic Coating On Top
<b>Taban / Base</b>	Plastik Kaplama Plastic Coating
<b>Ölçüler / Dimensions</b>	En: 30 cm Boy: 140 cm

**NVP 0117****Teknik Özellikler / Technical Specifications**

<b>Fener / Lattern</b>	Plastik Plastic
<b>Glop / Diffuse Dia</b>	30 cm
<b>Malzeme / Material</b>	60x3 mm Metal Boru Üstü Desenli Plastik Kaplama 60x3 mm Metal Pipe The patterned Plastic Coating On Top
<b>Taban / Base</b>	Plastik Kaplama Plastic Coating
<b>Ölçüler / Dimensions</b>	En: 155 cm Boy: 310 cm

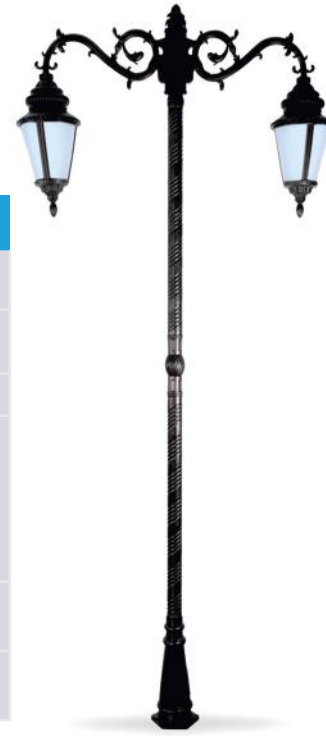
**NVP 0154****Teknik Özellikler /  
Technical Specifications**

<b>Fener / Lattern</b>	Plastik Plastic
<b>Glop / Diffuse Dia</b>	30 cm
<b>Malzeme / Material</b>	Plastik Plastic
<b>Ölçüler / Dimensions</b>	En: 30 cm Boy: 65 cm

**NVP 0156****Teknik Özellikler / Technical Specifications**

<b>Fener / Lattern</b>	Plastik Plastic
<b>Glop / Diffuse Dia</b>	30 cm
<b>Malzeme / Material</b>	48x3 mm Metal Boru Üstü Desenli Plastik Kaplama 48x3 mm Metal Pipe The patterned Plastic Coating On Top
<b>Taban / Base</b>	Plastik Kaplama Plastic Coating
<b>Ölçüler / Dimensions</b>	En: 30 cm Boy: 285 cm

**NVP 0159****Teknik Özellikler / Technical Specifications**

<b>Fener / Lattern</b>	Plastik Plastic
<b>Glop / Diffuse Dia</b>	30 cm
<b>Malzeme / Material</b>	48x3 mm Metal Boru Üstü Desenli Plastik Kaplama 48x3 mm Metal Pipe The patterned Plastic Coating On Top
<b>Taban / Base</b>	Plastik Kaplama Plastic Coating
<b>Ölçüler / Dimensions</b>	En: 90 cm Boy: 290 cm

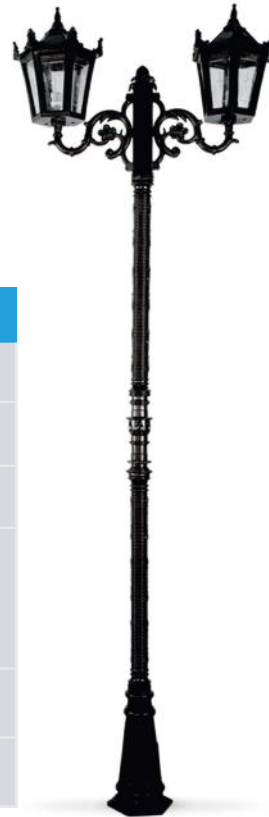
**NVP 0171****Teknik Özellikler / Technical Specifications**

<b>Fener / Lattern</b>	Plastik Plastic
<b>Glop / Diffuse Dia</b>	30 cm
<b>Malzeme / Material</b>	Plastik Plastic
<b>Taban / Base</b>	Plastik Plastic
<b>Ölçüler / Dimensions</b>	En: 30 cm Boy: 50 cm



NVP 0172	
Teknik Özellikler / <i>Technical Specifications</i>	
Fener / <i>Lattern</i>	Plastik <i>Plastic</i>
Glop / <i>Diffuse Dia</i>	30 cm
Malzeme / <i>Material</i>	Plastik <i>Plastic</i>
Ölçüler / <i>Dimensions</i>	En: 30 cm Boy: 50 cm



NVP 0175	
Teknik Özellikler / <i>Technical Specifications</i>	
Fener / <i>Lattern</i>	Plastik <i>Plastic</i>
Glop / <i>Diffuse Dia</i>	30 cm
Malzeme / <i>Material</i>	42x2 mm Metal Boru Üstü Desenli Plastik Kaplama 42x2 mm Metal Pipe The patterned Plastic Coating On Top
Taban / <i>Base</i>	Plastik <i>Plastic</i>
Ölçüler / <i>Dimensions</i>	En: 80 cm Boy: 120 cm



NVP 0180	
Teknik Özellikler / <i>Technical Specifications</i>	
Fener / <i>Lattern</i>	Plastik <i>Plastic</i>
Glop / <i>Diffuse Dia</i>	30 cm
Malzeme / <i>Material</i>	42x2 mm Metal Boru Üstü Desenli Plastik Kaplama 42x2 mm Metal Pipe The patterned Plastic Coating On Top
Taban / <i>Base</i>	Plastik <i>Plastic</i>
Ölçüler / <i>Dimensions</i>	En: 80 cm Boy: 120 cm

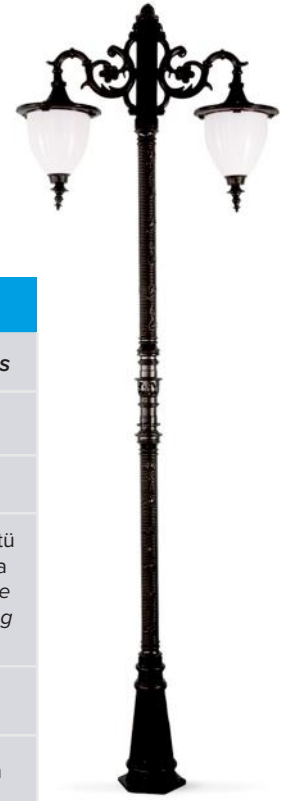

NVP 0183	
Teknik Özellikler / <i>Technical Specifications</i>	
Fener / <i>Lattern</i>	Plastik <i>Plastic</i>
Glop / <i>Diffuse Dia</i>	35 cm
Malzeme / <i>Material</i>	Plastik <i>Plastic</i>
Taban / <i>Base</i>	Plastik <i>Plastic</i>
Ölçüler / <i>Dimensions</i>	En: 35 cm Boy: 90 cm



NVP 0186	
Teknik Özellikler / <i>Technical Specifications</i>	
Fener / <i>Lattern</i>	Plastik <i>Plastic</i>
Glop / <i>Diffuse Dia</i>	35 cm
Malzeme / <i>Material</i>	Plastik <i>Plastic</i>
Ölçüler / <i>Dimensions</i>	En: 70 cm Boy: 85 cm



NVP 0191	
Teknik Özellikler / <i>Technical Specifications</i>	
Fener / <i>Lattern</i>	Plastik <i>Plastic</i>
Glop / <i>Diffuse Dia</i>	35 cm
Malzeme / <i>Material</i>	76x3 mm Metal Boru Üstü Desenli Plastik Kaplama ve Metal İsteğe Göre 76x3 mm Metal Pipe The patterned Plastic Coating On Top and Metal on Request
Taban / <i>Base</i>	Pik Döküm <i>Iron Cast</i>
Ölçüler / <i>Dimensions</i>	En: 35 cm Boy: 375 cm



NVP 0214	
Teknik Özellikler / Technical Specifications	
Fener / Lattern	Plastik Plastic
Glop / Diffuse Dia	15 cm
Malzeme / Material	Plastik Plastic
Ölçüler / Dimensions	En: 30 cm Boy: 40 cm



NVP 0220	
Teknik Özellikler / Technical Specifications	
Fener / Lattern	Plastik Plastic
Glop / Diffuse Dia	35 cm
Malzeme / Material	76x3 mm Metal Boru Üstü Desenli Plastik Kaplama ve Metal İsteğe Göre 76x3 mm Metal Pipe The patterned Plastic Coating On Top and Metal on Request
Taban / Base	Pik Döküm Iron Cast
Ölçüler / Dimensions	En: 60 cm Boy: 340 cm



NVP 0252	
Teknik Özellikler / Technical Specifications	
Fener / Lattern	Plastik Plastic
Glop / Diffuse Dia	30 cm
Malzeme / Material	Plastik Plastic
Ölçüler / Dimensions	En: 30 cm Boy: 60 cm



NVP 0253	
Teknik Özellikler / Technical Specifications	
Fener / Lattern	Plastik Plastic
Glop / Diffuse Dia	30 cm
Malzeme / Material	Plastik Plastic
Ölçüler / Dimensions	En: 30 cm Boy: 60 cm



NVP 0256	
Teknik Özellikler / Technical Specifications	
Fener / Lattern	Plastik Plastic
Glop / Diffuse Dia	30 cm
Malzeme / Material	Plastik Plastic
Ölçüler / Dimensions	En: 55 cm Boy: 60 cm



NVP 0257	
Teknik Özellikler / Technical Specifications	
Fener / Lattern	Plastik Plastic
Glop / Diffuse Dia	30 cm
Malzeme / Material	48x3 mm Metal Boru Üstü Desenli Plastik Kaplama 48x3 mm Metal Pipe The patterned Plastic Coating On Top
Taban / Base	Plastik Kaplama Plastic Coating
Ölçüler / Dimensions	En: 60 cm Boy: 340 cm



## NVP 0261

### Teknik Özellikler / Technical Specifications

Fener / Lattern	Plastik Plastic
Glop / Diffuse Dia	30 cm
Malzeme / Material	Plastik Plastic
Ölçüler / Dimensions	En: 32 cm Boy: 50 cm



## NVP 0261

### Teknik Özellikler / Technical Specifications

Fener / Lattern	Plastik Plastic
Glop / Diffuse Dia	30 cm
Malzeme / Material	Plastik Plastic
Ölçüler / Dimensions	En: 45 cm Boy: 55 cm



## NVP 0265

### Teknik Özellikler / Technical Specifications

Fener / Lattern	Plastik Plastic
Glop / Diffuse Dia	30 cm
Malzeme / Material	48x3 mm Metal Boru Üstü Desenli Plastik Kaplama 48x3 mm Metal Pipe The patterned Plastic Coating On Top
Taban / Base	Plastik Kaplama Plastic Coating
Ölçüler / Dimensions	En: 32 cm Boy: 200 cm



## NVP 0270

### Teknik Özellikler / Technical Specifications

Fener / Lattern	Plastik Plastic
Glop / Diffuse Dia	30 cm
Malzeme / Material	48x3 mm Metal Boru Üstü Desenli Plastik Kaplama 48x3 mm Metal Pipe The patterned Plastic Coating On Top
Taban / Base	Plastik Kaplama Plastic Coating
Ölçüler / Dimensions	En: 90 cm Boy: 280 cm



## NVP 0284

### Teknik Özellikler / Technical Specifications

Fener / Lattern	Plastik Plastic
Glop / Diffuse Dia	30 cm
Malzeme / Material	Plastik Plastic
Ölçüler / Dimensions	En: 25 cm Boy: 55 cm



NVP 0287	
Teknik Özellikler / Technical Specifications	
Fener / Lattern	Plastik Plastic
Glop / Diffuse Dia	25 cm
Malzeme / Material	42x2 mm Metal Boru Üstü Desenli Plastik Kaplama 42x2 mm Metal Pipe The patterned Plastic Coating On Top
Taban / Base	Plastik Plastic
Ölçüler / Dimensions	En: 70 cm Boy: 120 cm



NVP 0289	
Teknik Özellikler / Technical Specifications	
Fener / Lattern	Plastik Plastic
Glop / Diffuse Dia	25 cm
Malzeme / Material	48x3 mm Metal Boru Üstü Desenli Plastik Kaplama 48x3 mm Metal Pipe The patterned Plastic Coating On Top
Taban / Base	Plastik Kaplama Plastic Coating
Ölçüler / Dimensions	En: 70 cm Boy: 200 cm



NVP 0293	
Teknik Özellikler / Technical Specifications	
Fener / Lattern	Plastik Plastic
Glop / Diffuse Dia	25 cm
Malzeme / Material	48x3 mm Metal Boru Üstü Desenli Plastik Kaplama 48x3 mm Metal Pipe The patterned Plastic Coating On Top
Taban / Base	Plastik Kaplama Plastic Coating
Ölçüler / Dimensions	En: 20 cm Boy: 300 cm



NVP 0335	
Teknik Özellikler / Technical Specifications	
Fener / Lattern	Plastik Plastic
Glop / Diffuse Dia	25 cm
Malzeme / Material	48x3 mm Metal Boru Üstü Desenli Plastik Kaplama 48x3 mm Metal Pipe The patterned Plastic Coating On Top
Taban / Base	Plastik Kaplama Plastic Coating
Ölçüler / Dimensions	En: 85 cm Boy: 290 cm



NVP 0372	
Teknik Özellikler / Technical Specifications	
Fener / Lattern	Plastik Plastic
Glop / Diffuse Dia	25 cm
Malzeme / Material	48x3 mm Metal Boru Üstü Desenli Plastik Kaplama 48x3 mm Metal Pipe The patterned Plastic Coating On Top
Taban / Base	Plastik Kaplama Plastic Coating
Ölçüler / Dimensions	En: 130 cm Boy: 320 cm





## NVP 0418

### Teknik Özellikler / Technical Specifications

Fener / Lattern	Plastik Plastic
Glop / Diffuse Dia	25 cm
Malzeme / Material	48x3 mm Metal Boru Üstü Desenli Plastik Kaplama 48x3 mm Metal Pipe The patterned Plastic Coating On Top
Korkuluk / Scarecrow	Alüminyum Kasa / Aluminum Case
İçi / In	Plastik Model / Plastic Model
Çatı / Roof	Shingle Kaplama / Shingle Coating
Ölçüler / Dimensions	En: 330 cm Boy: 470 cm



## NVP 0418

### Teknik Özellikler / Technical Specifications

Fener / Lattern	Plastik Plastic
Glop / Diffuse Dia	25 cm
Malzeme / Material	48x3 mm Metal Boru Üstü Desenli Plastik Kaplama 48x3 mm Metal Pipe The patterned Plastic Coating On Top
Korkuluk / Scarecrow	Alüminyum Kasa / Aluminum Case
İçi / In	Plastik Model / Plastic Model
Çatı / Roof	Shingle Kaplama / Shingle Coating
Ölçüler / Dimensions	En: 300 cm Boy: 300 cm



### NVP 0432

#### Teknik Özellikler / Technical Specifications

Fener / Lattern	Plastik Plastic
Glop / Diffuse Dia	15 cm
Malzeme / Material	76x3 mm Metal Boru Üstü Desenli Plastik Kaplama ve Metal İsteğe Göre 76x3 mm Metal Pipe The patterned Plastic Coating On Top and Metal on Request
Taban / Base	Alüminyum Döküm Aluminum Casting
Ölçüler / Dimensions	En: 150 cm Boy: 370 cm

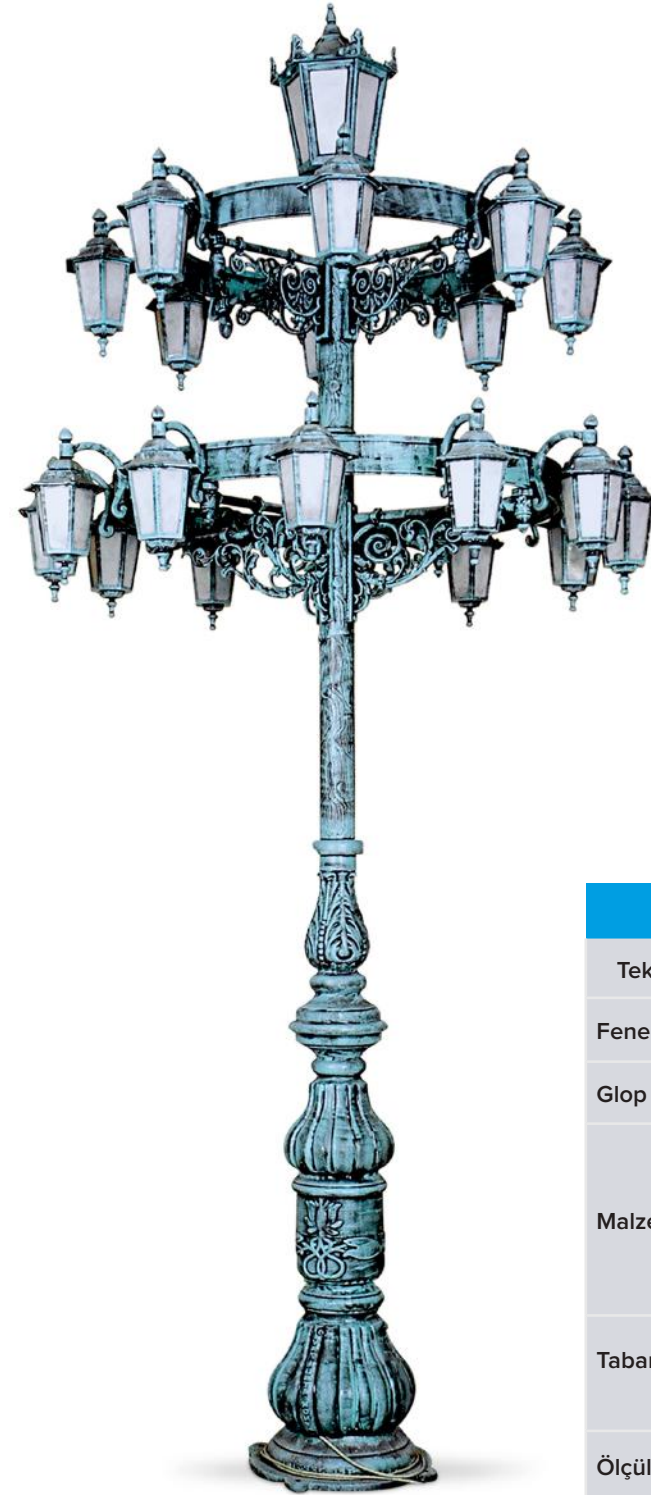

### NVP 0434

#### Teknik Özellikler / Technical Specifications

Fener / Lattern	Plastik Plastic
Glop / Diffuse Dia	20 cm
Malzeme / Material	76x3 mm Metal Boru Üstü Desenli Plastik Kaplama ve Metal İsteğe Göre 76x3 mm Metal Pipe The patterned Plastic Coating On Top and Metal on Request
Taban / Base	Alüminyum Döküm Aluminum Casting
Ölçüler / Dimensions	En: 150 cm Boy: 360 cm





## NVP 0447

### Teknik Özellikler / Technical Specifications

#### Malzeme / Material

Ahşap ve Alüminyum Döküm  
Wood and Aluminum Casting

#### Ölçüler / Dimensions

En: 120 cm Boy: 75 cm

## NVP 0448

### Teknik Özellikler / Technical Specifications

#### Malzeme / Material

Ahşap ve Alüminyum Döküm  
Wood and Aluminum Casting

#### Ölçüler / Dimensions

En: 120 cm Boy: 75 cm



## NVP 0452

### Teknik Özellikler / Technical Specifications

#### Malzeme / Material

Ahşap ve Alüminyum Döküm  
Wood and Aluminum Casting

#### Ölçüler / Dimensions

En: 150 cm Boy: 70 cm



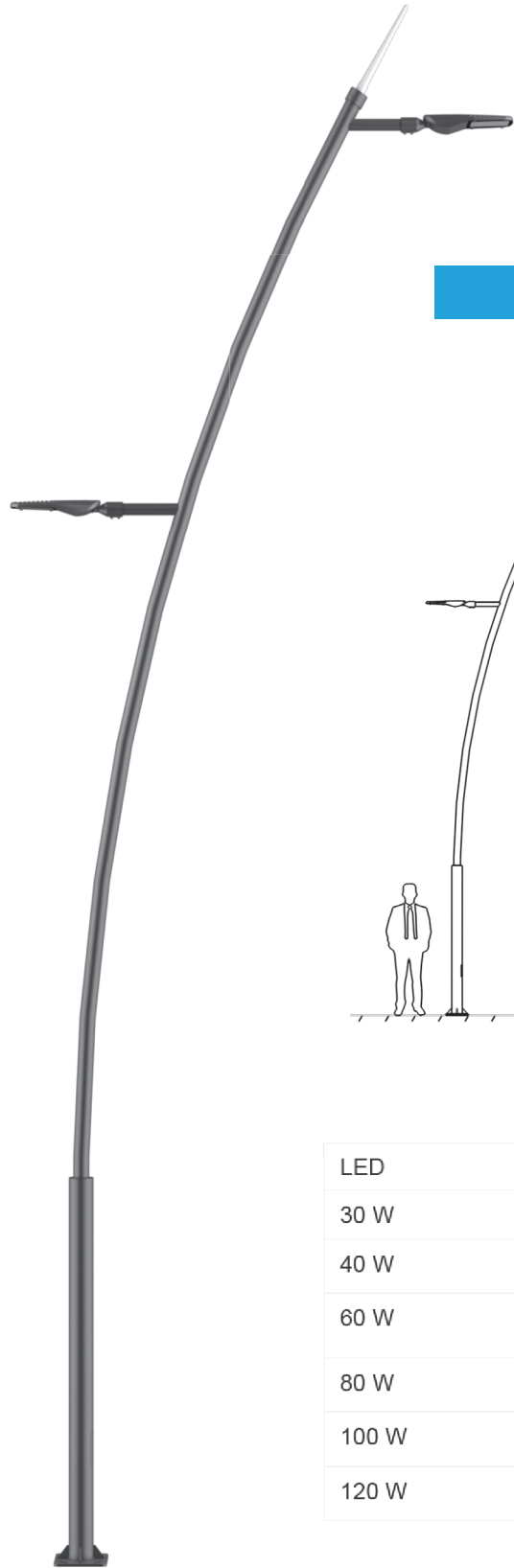

## NVP 1000

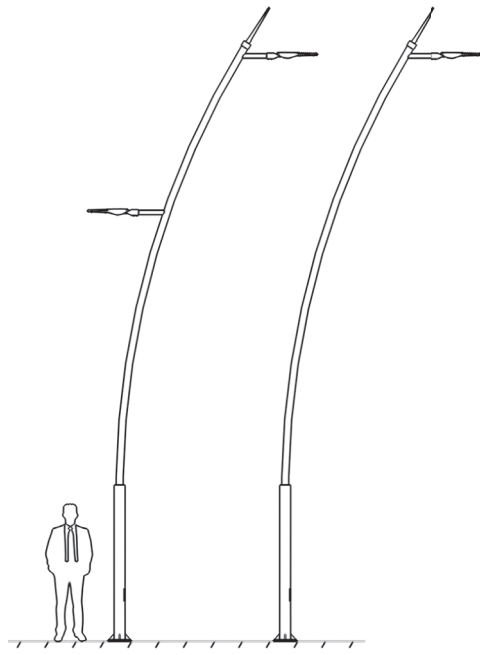

- Galvanized steel housing and pole are powder coating with high corrosion resistance and chemical chromatised protection
- Stainless steel fasteners in grade 316
- Durable silicone rubber gasket
- Clear toughened glass
- The maximum wind load resistance is 100km/hrs.

LED		Lumen	AC/DC	Pole Height	Pole Top
30 W	DALI controllable	3600	√	3000-5000	60
40 W	DALI controllable	4800	√	4000-6000	60
60 W	DALI controllable	7200	√	5000-8000	60
80 W	DALI controllable	9600	√	6000-10000	60
100 W	DALI controllable	11200	√	8000-11000	60
120 W	DALI controllable	13440	√	8000-12000	60

### Colour temperature



Warm white > 3.000 K



Neutral white > 4.000 K



Cool white > 5000 K

### Light distributions

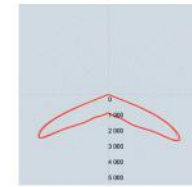

Symmetrical

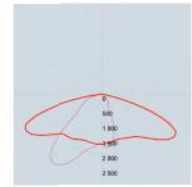

Asymmetric



Discover the potential

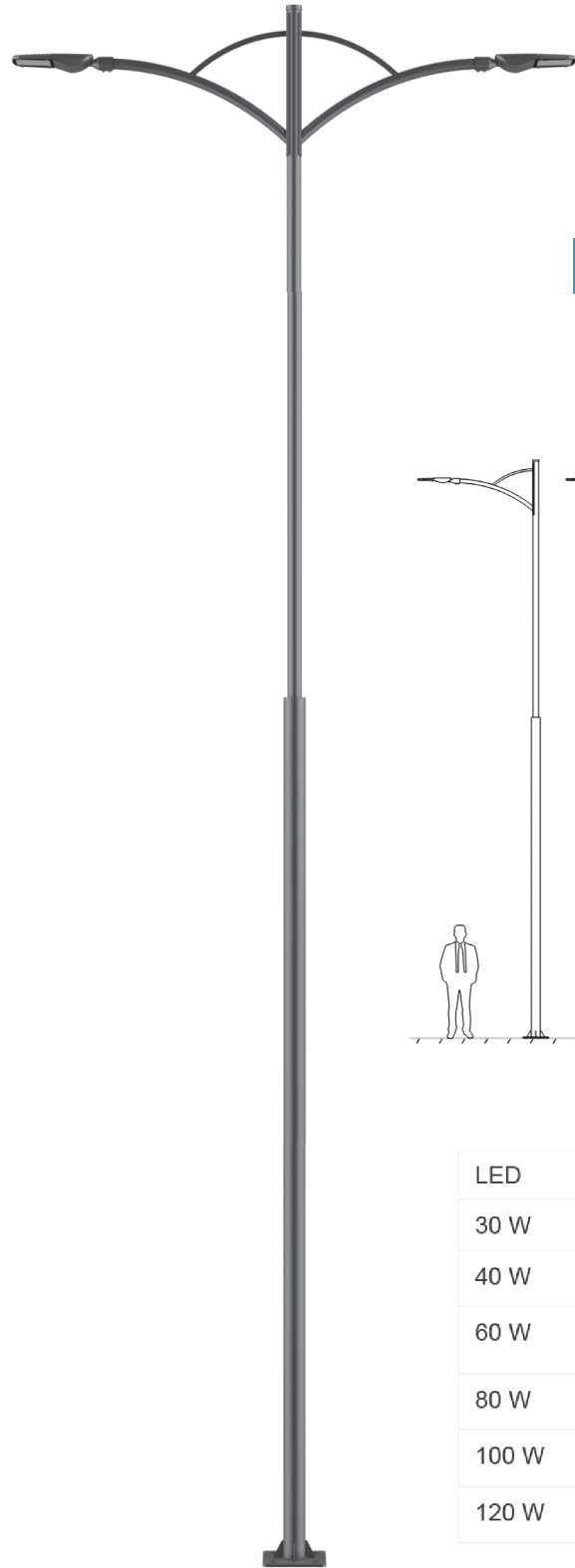

## NVP 1001

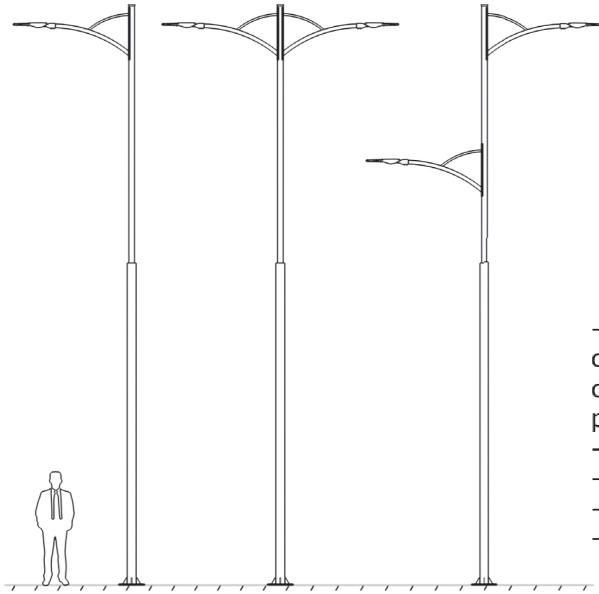

- Galvanized steel housing and pole are powder coating with high corrosion resistance and chemical chromatised protection
- Stainless steel fasteners in grade 316
- Durable silicone rubber gasket
- Clear toughened glass
- The maximum wind load resistance is 100km/hrs.

LED		Lumen	AC/DC	Pole Height	Pole Top
30 W	DALI controllable	3600	√	3000-5000	60
40 W	DALI controllable	4800	√	4000-6000	60
60 W	DALI controllable	7200	√	5000-8000	60
80 W	DALI controllable	9600	√	6000-10000	60
100 W	DALI controllable	11200	√	8000-11000	60
120 W	DALI controllable	13440	√	8000-12000	60

### Colour temperature



Warm white > 3.000 K



Neutral white > 4.000 K



Cool white > 5000 K

### Light distributions

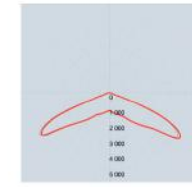

Symmetrical



Asymmetric



Discover the potential

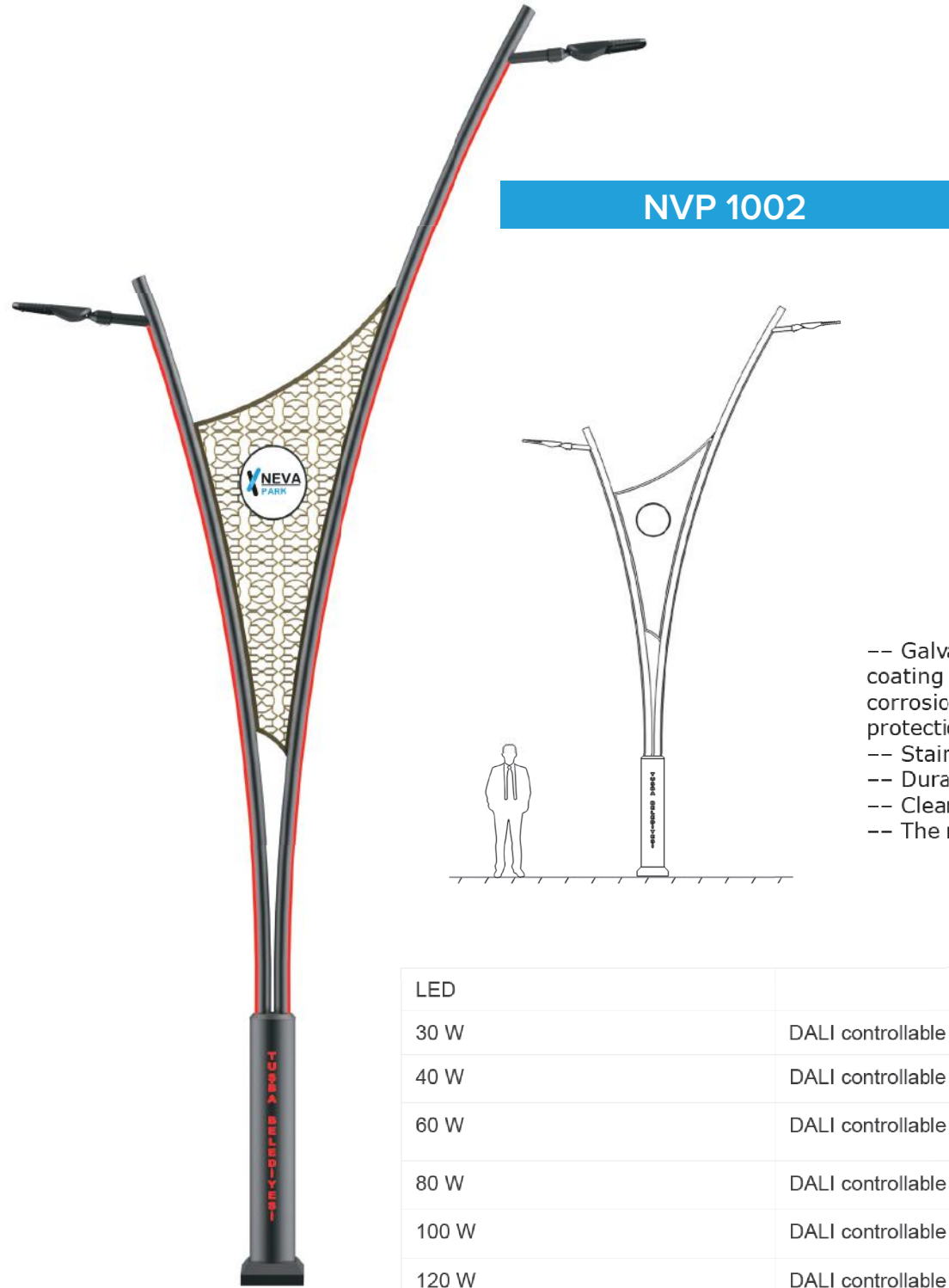

**NVP 1002**

- Galvanized steel housing and pole are powder coating with high corrosion resistance and chemical chromatised protection
- Stainless steel fasteners in grade 316
- Durable silicone rubber gasket
- Clear toughened glass
- The maximum wind load resistance is 100km/hrs.

Colour temperature

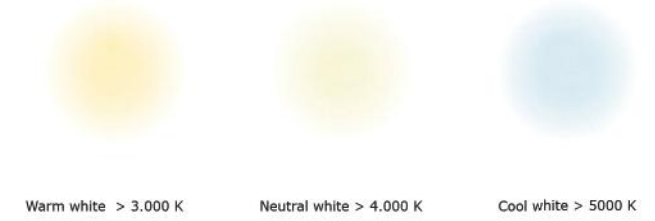

Light distributions

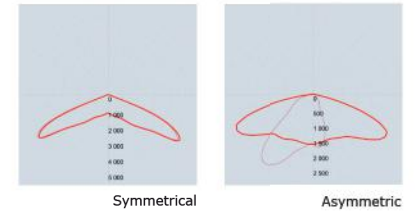

LED		Lumen	AC/DC	Pole Height	Pole Top
30 W	DALI controllable	3600	√	3000-5000	60
40 W	DALI controllable	4800	√	4000-6000	60
60 W	DALI controllable	7200	√	5000-8000	60
80 W	DALI controllable	9600	√	6000-10000	60
100 W	DALI controllable	11200	√	8000-11000	60
120 W	DALI controllable	13440	√	8000-12000	60



## NVP 1003

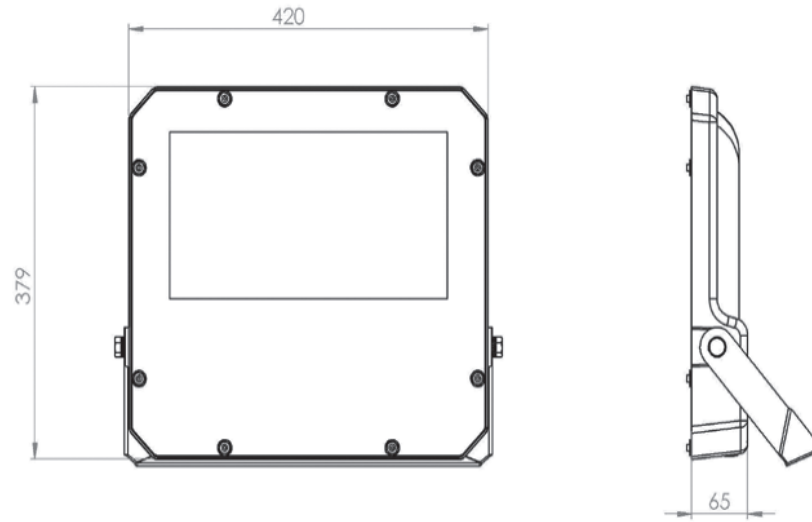

- \*Panel 1 DALI address
- \*Current feed: 400 mA–1200 mA
- \*Electronic operating device with DALI interface or 1–10 V
- \*Allowed ambient temperature range –40 to +55 °C
- \*Various light distributions for large area, high bay or street lighting
- \*Lens made from PMMA
- \*Lamp housing in die-cast aluminum, cover in single-pane safety glass (ESG)
- \*Bracket made of hot-dip galvanized steel, holder made of aluminum

### Colour temperature

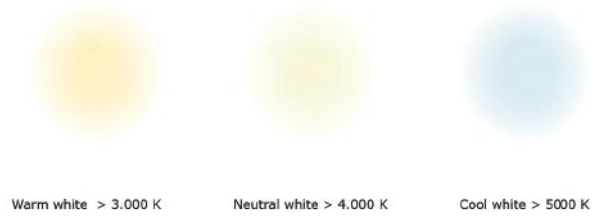

### Light distributions

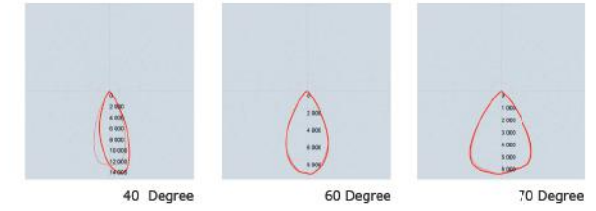

LED		Lumen	AC/DC
50 W	DALI controllable	5600	√
70 W	DALI controllable	7800	√
90 W	DALI controllable	10200	√
100 W	DALI controllable	11200	√
120 W	DALI controllable	13440	√
150 W	DALI controllable	16800	√
180 W	DALI controllable	20180	√
200 W	DALI controllable	22200	√



## NVP 1004

Colour temperature



Warm white > 3.000 K



Neutral white > 4.000 K



Cool white > 5000 K

Light distributions

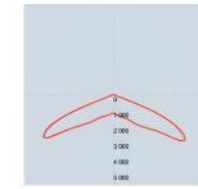

Symmetrical

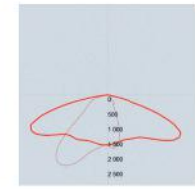

Asymmetric

- \*Housing accommodates up to 5 LED lighting units (LED Board: 32 / 48 / 64 / 80 LED)
- \*Current feed: 200 mA-1500 mA, depending on ambient temperature
- \*Electronic operating device with DALI interface, 1-10 V or stand-alone programming
- \*Various light distributions for area, high bay, street or walkway lighting
- \*Lens made from PMMA, with aluminum support plate
- \*Cover in single-pane safety glass
- \*Die-cast aluminum housing, pole adapter made of aluminum, swivels from 0 to 90° in 5° increments, for pole □ 60 mm
- \*Finish: polyester



Discover the potential

LED		Lumen	AC/DC	Pole Height	Pole Top
30 W	DALI controllable	3600	√	3000-5000	60
40 W	DALI controllable	4800	√	4000-6000	60
60 W	DALI controllable	7200	√	5000-8000	60
80 W	DALI controllable	9600	√	6000-10000	60

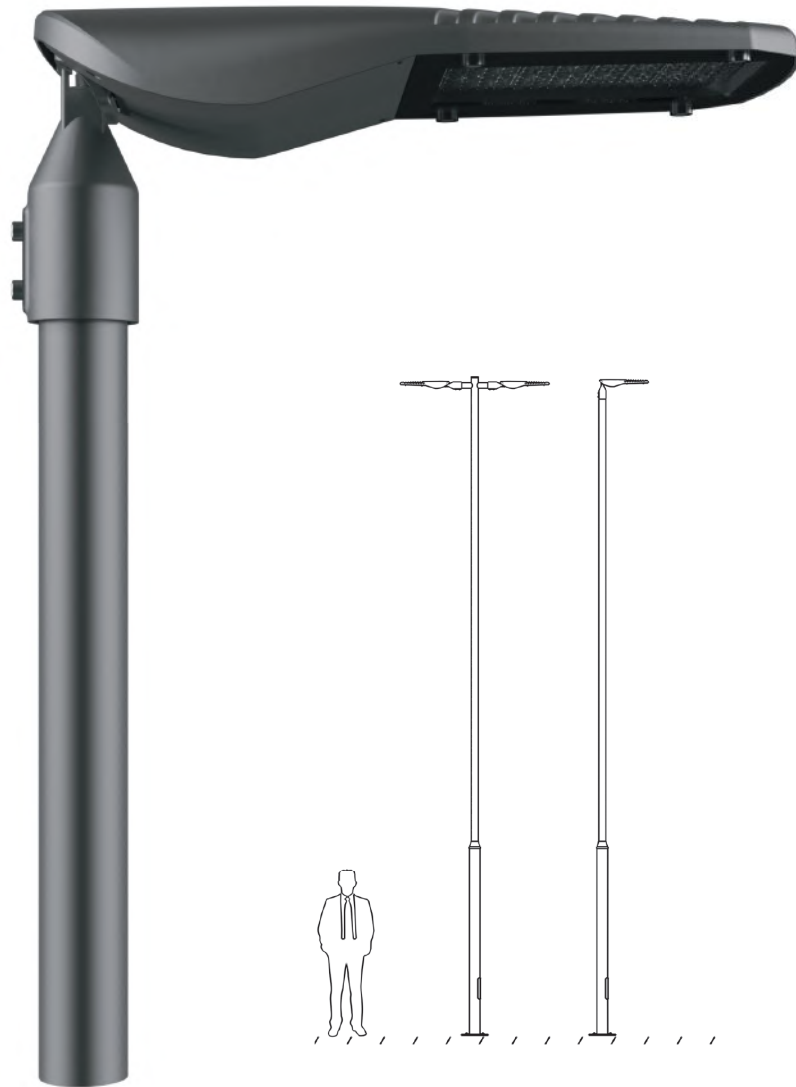

## NVP 1005

Colour temperature



Warm white > 3.000 K



Neutral white > 4.000 K



Cool white > 5000 K

Light distributions

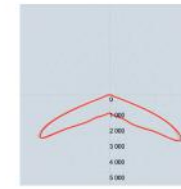

Symmetrical

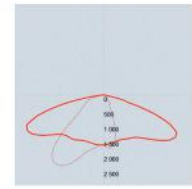

Asymmetrical

- \*Housing accommodates up to 5 LED lighting units (LED Board: 32 / 48 / 64 / 80 LED)
- \*Current feed: 200 mA-1500 mA, depending on ambient temperature
- \*Electronic operating device with DALI interface, 1-10 V or stand-alone programming
- \*Various light distributions for area, high bay, street or walkway lighting
- \*Lens made from PMMA, with aluminum support plate
- \*Cover in single-pane safety glass
- \*Die-cast aluminum housing, pole adapter made of aluminum, swivels from 0 to 90° in 5° increments, for pole □ 60 mm
- \*Finish: polyester



Discover the potential

LED		Lumen	AC/DC	Pole Height	Pole Top
30 W	DALI controllable	3600	√	3000-5000	60
40 W	DALI controllable	4800	√	4000-6000	60
60 W	DALI controllable	7200	√	5000-8000	60
80 W	DALI controllable	9600	√	6000-10000	60
100 W	DALI controllable	11200	√	8000-11000	60
120 W	DALI controllable	13440	√	8000-12000	60
140 W	DALI controllable	18500	√	8000-12000	60

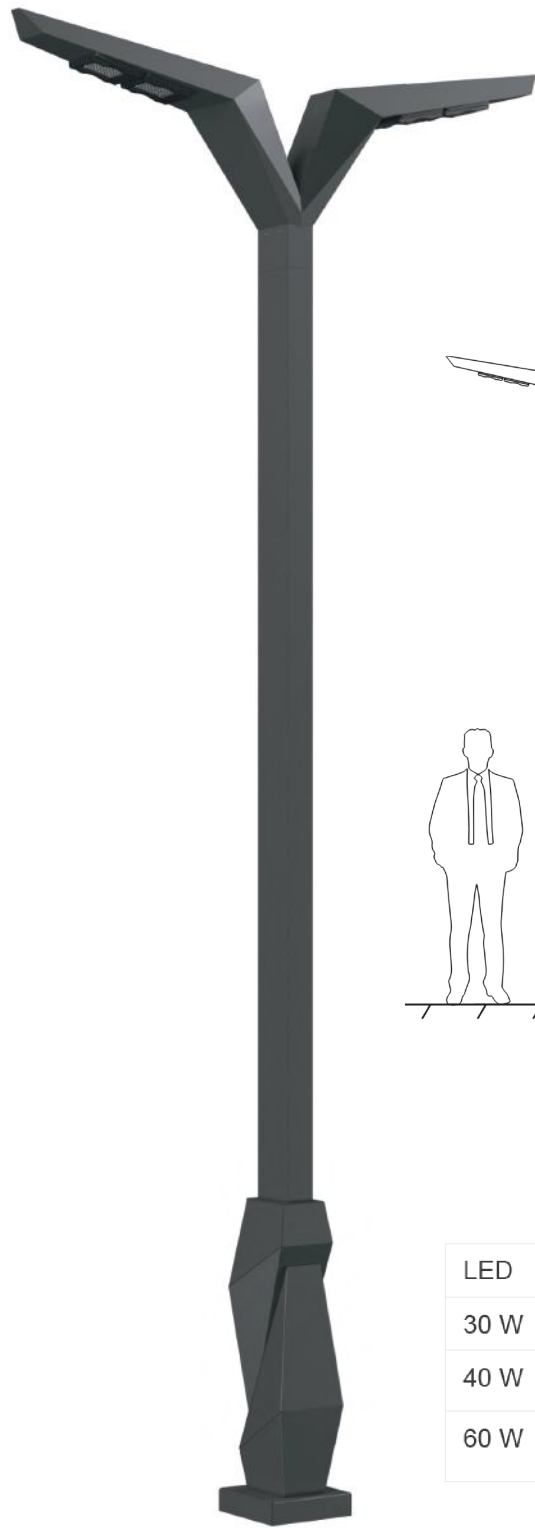

## NVP 1006

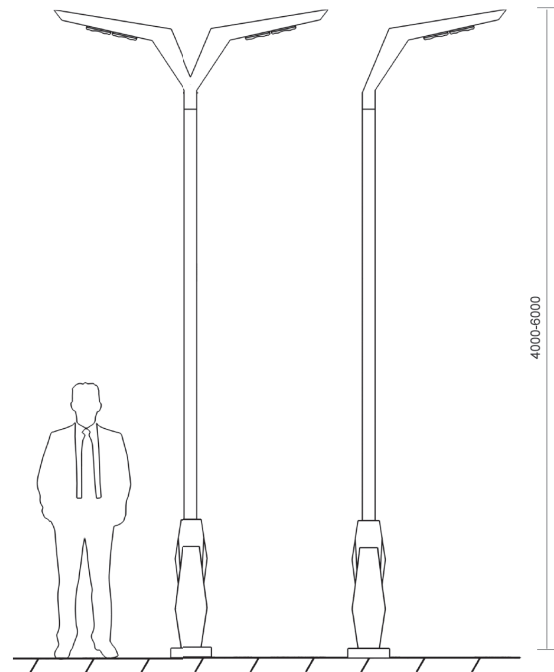

- \*Housing accommodates up to 6 LED lighting units (LED Board: 16 / 32 / 48 / 64 / 80 / 96 LED)
- \*Current feed: 200 mA-1500 mA, depending on ambient temperature
- \*Electronic operating device with DALI interface, 1-10 V or stand-alone programming
- \*Various light distributions for area, high bay, street or walkway lighting
- \*Lens made from PMMA, with aluminum support plate
- \*Housing made of extruded aluminum profile, cover in single-pane safety glass
- \*Pole in hot-dip galvanized steel with cable insertion opening, junction box and service door
- \*Finish: polyester powder coating, anthracite, other colours upon request

### Colour temperature



Warm white > 3.000 K



Neutral white > 4.000 K



Cool white > 5000 K

### Light distributions



Symmetrical



Asymmetric



Discover the potential

LED		Lumen	AC/DC	Pole Height	Pole Top
30 W	DALI controllable	3600	√	3000-5000	80x150
40 W	DALI controllable	4800	√	4000-6000	80x150
60 W	DALI controllable	7200	√	5000-8000	80x150



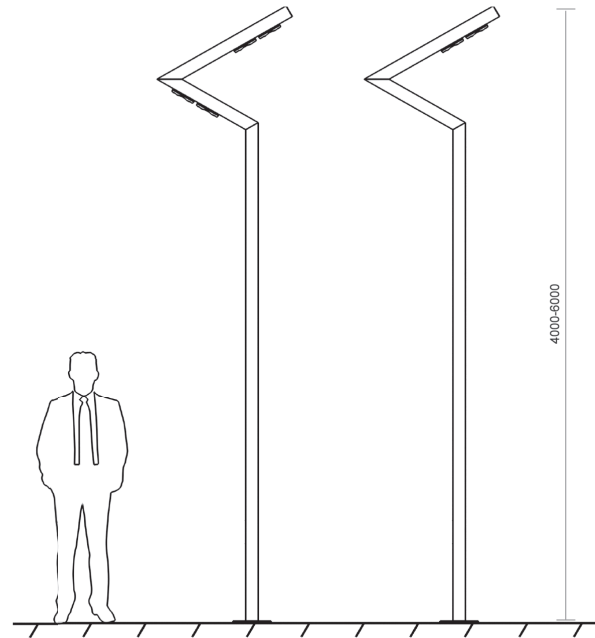

## NVP 1007

- \*Housing accommodates up to 6 LED lighting units (LED Board: 16 / 32 / 48 / 64 / 80 / 96 LED)
- \*Current feed: 200 mA-1500 mA, depending on ambient temperature
- \*Electronic operating device with DALI interface, 1-10 V or stand-alone programming
- \*Various light distributions for area, high bay, street or walkway lighting
- \*Lens made from PMMA, with aluminum support plate
- \*Housing made of extruded aluminum profile, cover in single-pane safety glass
- \*Pole in hot-dip galvanized steel with cable insertion opening, junction box and service door
- \*Finish: polyester powder coating, anthracite, other colours upon request

### Colour temperature



Warm white > 3.000 K



Neutral white > 4.000 K



Cool white > 5000 K

### Light distributions

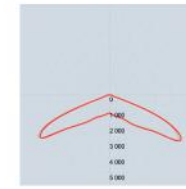

Symmetrical

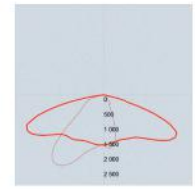

Asymmetrical



Discover the potential

LED		Lumen	AC/DC	Pole Height	Pole Top
30 W	DALI controllable	3600	√	3000-5000	80x150
40 W	DALI controllable	4800	√	4000-6000	80x150
60 W	DALI controllable	7200	√	5000-8000	80x150

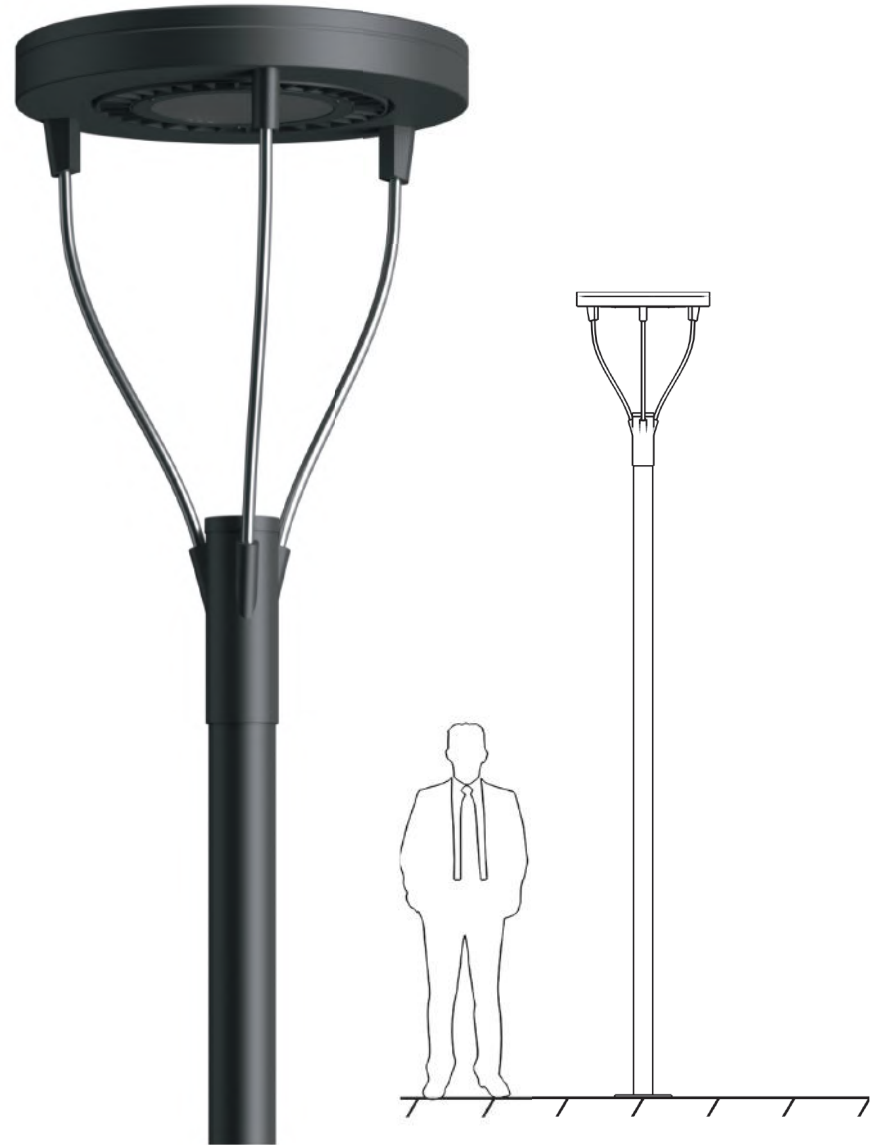

## NVP 1008

Colour temperature



Warm white > 3.000 K



Neutral white > 4.000 K



Cool white > 5000 K

Light distributions



- \*Housing accommodates up to 3 LED lighting units (LED Board: 16 / 24 LED)
- \*Current feed: 200 mA-1500 mA, depending on ambient temperature
- \*Electronic operating device with DALI interface, 1-10 V or stand-alone programming
- \*Various light distributions for area, high bay, street or walkway lighting
- \*Lens made from PMMA, with aluminum support plate
- \*Housing made of aluminum, pole adaptor made of aluminum, cover in single-pane safety glass (ESG)
- \*Pole in hot-dip galvanized steel with cable insertion opening, junction box and service door
- \*Finish: polyester



Discover the potential

LED		Lumen	AC/DC	Pole Height	Pole Top
60 W	DALI controllable	7200	√	3000-6000	80x80



## NVP 1009

Colour temperature



Warm white > 3.000 K



Neutral white > 4.000 K



Cool white > 5000 K

Light distributions



Symmetrical

- \*Housing accommodates up to 3 LED lighting units (LED Board: 16 / 24 LED)
- \*Current feed: 200 mA–1500 mA, depending on ambient temperature
- \*Electronic operating device with DALI interface, 1–10 V or stand-alone programming
- \*Various light distributions for area, high bay, street or walkway lighting
- \*Lens made from PMMA, with aluminum support plate
- \*Housing made of aluminum, pole adaptor made of aluminum, cover in single-pane safety glass (ESG)
- \*Pole in hot-dip galvanized steel with cable insertion opening, junction box and service door
- \*Finish: polyester



Discover the potential

LED		Lumen	AC/DC	Pole Height	Pole Top
60 W	DALI controllable	7200	√	3000-6000	89

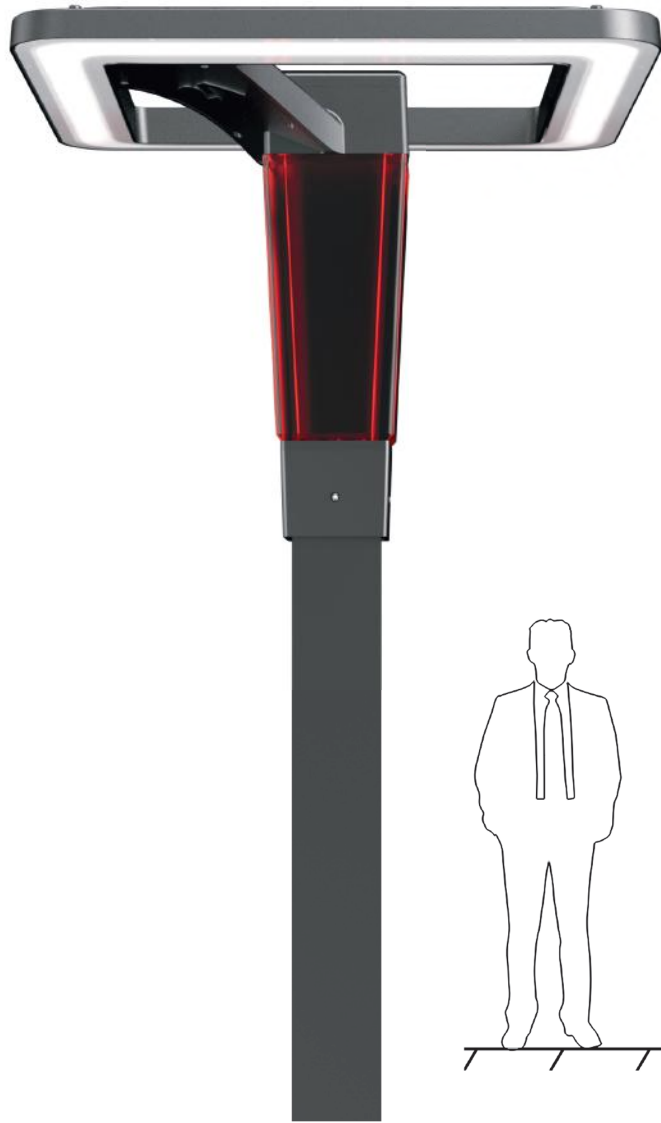

## NVP 1010

- \*Housing accommodates up to 3 LED lighting units (LED Board: 16 / 24 LED)
- \*Current feed: 200 mA–1500 mA, depending on ambient temperature
- \*Electronic operating device with DALI interface, 1–10 V or stand-alone programming
- \*Various light distributions for area, high bay, street or walkway lighting
- \*Lens made from PMMA, with aluminum support plate
- \*Housing made of aluminum, pole adaptor made of aluminum, cover in single-pane safety glass (ESG)
- \*Pole in hot-dip galvanized steel with cable insertion opening, junction box and service door
- \*Finish: polyester

### Colour temperature



Warm white > 3.000 K



Neutral white > 4.000 K



Cool white > 5000 K

### Light distributions

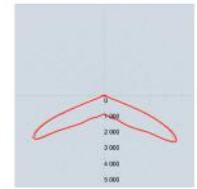

Symmetrical



Discover the potential

LED		Lumen	AC/DC	Pole Height	Pole Top
60 W	DALI controllable	7200	√	3000-6000	80x80

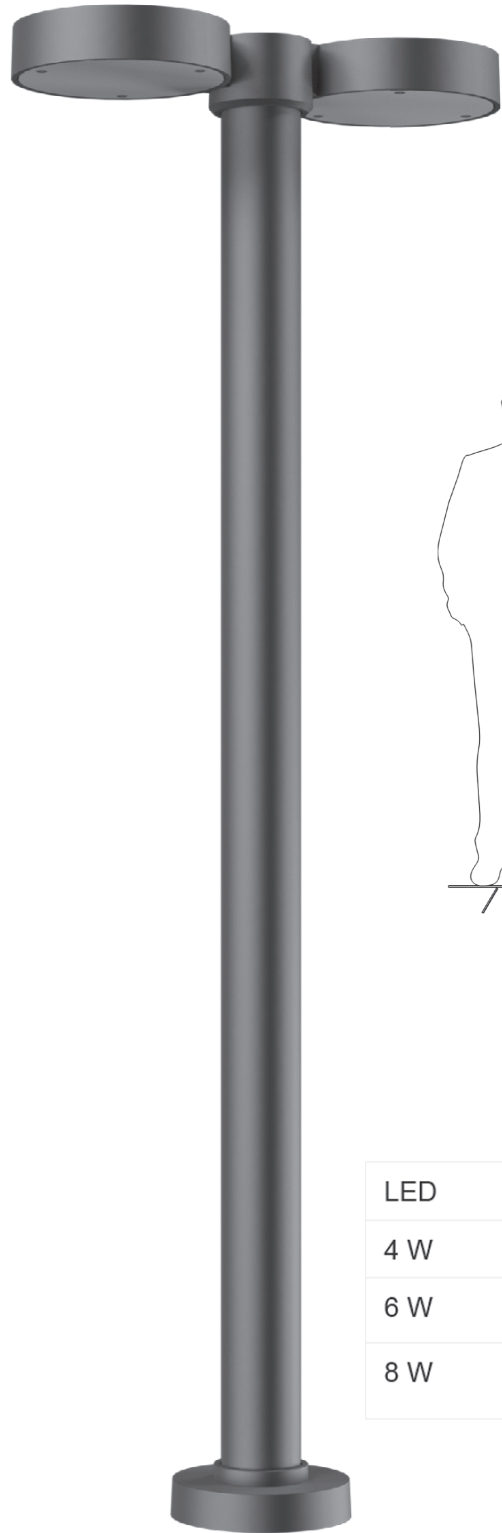

## NVP 1011

Colour temperature



Warm white > 3.000 K



Neutral white > 4.000 K



Cool white > 5000 K

Light distributions



Symmetrical



Asymmetrical

- \*Various light distributions for walkway lighting
- \*Lens made from PMMA
- \*Current feed: 200 mA-700 mA, depending on ambient temperature
- \*Housing made of aluminum
- \*Pole made of extruded aluminum profile
- \*Finish: polyester powder coating, black \*(RAL 9005), other colours upon request



Discover the potential

LED		Lumen	AC/DC	Pole Height	LED
4 W	DALI controllable	440	√	200- 1000	4
6 W	DALI controllable	670	√	200- 1000	8
8 W	DALI controllable	890	√	200- 1500	8

# NEVA

TRAFİK





NVT 2030	
ESNEK ŞERİT AYIRICI DELİNATÖR 30 CM	FLEXIBLE DELINEATOR 30 CM (TPU)
Teknik Özellikler / Technical Specifications	
Malzeme / Material	TPU
Yükseklik / Height	30 cm
Renk / Color	Turuncu / Orange
Üst Çap / Top Diameter	8 cm
Alt Çap / Bottom Diameter	21 cm
Ağırlık / Weight	0,610 kg ± 0,1 kg
<ul style="list-style-type: none"> <li>Aparat takarak tabela ve flaşörler kolaylıkla monte edilebilir. (NVT 2400)</li> <li>The board and flashers can be mounted easily with apparatus. (NVT 2400)</li> </ul>	



NVT 2045	
ESNEK ŞERİT AYIRICI DELİNATÖR 45 CM (TPU)	FLEXIBLE DELINEATOR 45 CM (TPU)
Teknik Özellikler / Technical Specifications	
Malzeme / Material	TPU
Yükseklik / Height	45 cm
Renk / Color	Turuncu / Orange
Üst Çap / Top Diameter	8 cm
Alt Çap / Bottom Diameter	21 cm
Ağırlık / Weight	0,760 kg ± 0,1 kg
<ul style="list-style-type: none"> <li>Aparat takarak tabela ve flaşörler kolaylıkla monte edilebilir. (NVT 2400)</li> <li>The board and flashers can be mounted easily with apparatus. (NVT 2400)</li> </ul>	



NVT 2046	
ESNEK ŞERİT AYIRICI DELİNATÖR 45 CM (TPE)	FLEXIBLE DELINEATOR 45 CM (TPE)
Teknik Özellikler / Technical Specifications	
Malzeme / Material	TPE
Yükseklik / Height	45 cm
Renk / Color	Turuncu / Orange
Üst Çap / Top Diameter	8 cm
Alt Çap / Bottom Diameter	21 cm
Ağırlık / Weight	580 gr
<ul style="list-style-type: none"> <li>Aparat takarak tabela ve flaşörler kolaylıkla monte edilebilir. (NVT 2400)</li> <li>The board and flashers can be mounted easily with apparatus. (NVT 2400)</li> </ul>	



NVT 2070	
EKO DELİNATÖR 70 CM	FLEXIBLE DELINEATOR 70 CM (TPU)
Teknik Özellikler / Technical Specifications	
Malzeme / Material	TPU
Yükseklik / Height	73 cm
Renk / Color	Turuncu / Orange
Üst Çap / Top Diameter	8 cm
Alt Çap / Bottom Diameter	18 cm
Ağırlık / Weight	0,940 kg ± 0,1 kg
<ul style="list-style-type: none"> <li>Aparat takarak tabela ve flaşörler kolaylıkla monte edilebilir. (NVT 2400)</li> <li>The board and flashers can be mounted easily with apparatus. (NVT 2400)</li> </ul>	



NVT 2071	
EKO DELİNATÖR 70 CM	FLEXIBLE DELINEATOR 70 CM
Teknik Özellikler / Technical Specifications	
Malzeme / Material	TPE
Yükseklik / Height	73 cm
Renk / Color	Turuncu / Orange
Üst Çap / Top Diameter	8 cm
Alt Çap / Bottom Diameter	18 cm
Ağırlık / Weight	660 gr
<ul style="list-style-type: none"> <li>Aparat takarak tabela ve flaşörler kolaylıkla monte edilebilir. (NVT 2400)</li> <li>The board and flashers can be mounted easily with apparatus. (NVT 2400)</li> </ul>	



NVT 2075	
ESNEK ŞERİT AYIRICI DELİNATÖR 75 CM	ESNEK ŞERİT AYIRICI DELİNATÖR 75 CM
Teknik Özellikler / Technical Specifications	
Malzeme / Material	TPU
Yükseklik / Height	75 cm
Renk / Color	Turuncu / Orange
Üst Çap / Top Diameter	8 cm
Alt Çap / Bottom Diameter	21 cm
Ağırlık / Weight	1,31 kg ± 0,1 kg
<ul style="list-style-type: none"> <li>Aparat takarak tabela ve flaşörler kolaylıkla monte edilebilir. (NVT 2400)</li> <li>The board and flashers can be mounted easily with apparatus. (NVT 2400)</li> </ul>	





NVT 2100	
ESNEK ŞERİT AYIRICI DELİNATÖR 100 CM	FLEXIBLE DELINEATOR 100 CM
Teknik Özellikler / Technical Specifications	
Malzeme / Material	TPU
Yükseklik / Height	100 cm
Renk / Color	Turuncu / Orange
Üst Çap / Top Diameter	8 cm
Alt Çap / Bottom Diameter	21 cm
Ağırlık / Weight	1,5 kg ± 0,1 kg
<ul style="list-style-type: none"> <li>Aparat takarak tabela ve flaşörler kolaylıkla monte edilebilir. (NVT 2400)</li> <li>The board and flashers can be mounted easily with apparatus. (NVT 2400)</li> </ul>	



NVT 2185	
ESNEK REFÜJ BAŞI 85 CM TURUNCU	REFUGE SIGN 85 CM ORANGE
Teknik Özellikler / Technical Specifications	
Malzeme / Material	TPU
Yükseklik / Height	85 cm
Renk / Color	Turuncu / Orange
En / Width	20 cm
Ağırlık / Weight	1,6 kg ± 0,1 kg



NVT 2186	
ESNEK REFÜJ BAŞI 85 CM SİYAH	REFUGE SIGN 85 CM BLACK
Teknik Özellikler / Technical Specifications	
Malzeme / Material	TPU
Yükseklik / Height	85 cm
Renk / Color	Siyah / Black
En / Width	20 cm
Ağırlık / Weight	1,6 kg ± 0,1 kg



NVT 2195	
ESNEK REFÜJ BAŞI 95 CM TURUNCU	REFUGE SIGN 95 CM ORANGE
Teknik Özellikler / Technical Specifications	
Malzeme / Material	TPU
Yükseklik / Height	95 cm
Renk / Color	Turuncu / Orange
En / Width	30 cm
Ağırlık / Weight	3,3 kg ± 0,1 kg



NVT 2196	
ESNEK REFÜJ BAŞI 95 CM SİYAH	REFUGE SIGN 95 CM BLACK
Teknik Özellikler / Technical Specifications	
Malzeme / Material	TPU
Yükseklik / Height	95 cm
Renk / Color	Siyah / Black
En / Width	30 cm
Ağırlık / Weight	3,3 kg ± 0,1 kg



NVT 2400	
DELİNATÖR APARATI	DELINEATOR APPARATUS
Teknik Özellikler / Technical Specifications	
Malzeme / Material	PP
Çap / Diameter	80 x 80 mm
Renk / Color	Siyah / Black
Ağırlık / Weight	90 gr



NVT 2410	
DELİNATOR APARATI	DELINEATOR APPARATUS
Teknik Özellikler / Technical Specifications	
Malzeme / Material	PP
Renk / Color	Beyaz / White
Ağırlık / Weight	20 gr



NVT 2420	
ZİNCİR APARATI	CHAIN APPARATUS
Teknik Özellikler / Technical Specifications	
Ölçüler / Dimensions	10 x 100 mm
Ağırlık / Weight	56 gr



NVT 2430	
PLASTİK DUBEL	PLASTIC DOWEL
Teknik Özellikler / Technical Specifications	
Ölçüler / Dimensions	16 x 85 mm
Ağırlık / Weight	10 gr



NVT 3052	
PVC TRAFİK KONİSİ 52 CM (REFLEKTİFSİZ)	PVC CONE 52 CM
Teknik Özellikler / Technical Specifications	
Malzeme / Material	PVC
Ölçüler / Dimensions	38 x 52 cm
Renk / Color	Turuncu / Orange
Ağırlık / Weight	1,3 kg ± 0,1 kg
<ul style="list-style-type: none"> <li>Aparat takarak tabela ve flaşörler kolaylıkla monte edilebilir. (NVT 3900)</li> <li>The board and flashers can be mounted easily with apparatus. (NVT 3900)</li> </ul>	



NVT 3152	
PVC TRAFİK KONİSİ 52 CM (REFLEKTİFSİZ)	PVC CONE 52 CM (ONE REFLECTIVE)
Teknik Özellikler / Technical Specifications	
Malzeme / Material	PVC
Ölçüler / Dimensions	33 x 52 cm
Renk / Color	Turuncu / Orange
Ağırlık / Weight	1,3 kg ± 0,1 kg
<ul style="list-style-type: none"> <li>Aparat takarak tabela ve flaşörler kolaylıkla monte edilebilir. (NVT 3900)</li> <li>The board and flashers can be mounted easily with apparatus. (NVT 3900)</li> </ul>	



NVT 3252	
PVC TRAFİK KONİSİ 52 CM (ÇİFT REFLEKTİFLİ)	PVC CONE 52 CM (TWO REFLECTIVE)
Teknik Özellikler / Technical Specifications	
Malzeme / Material	PVC
Ölçüler / Dimensions	38 x 52 cm
Renk / Color	Turuncu / Orange
Ağırlık / Weight	1,3 kg ± 0,1 kg
<ul style="list-style-type: none"> <li>Aparat takarak tabela ve flaşörler kolaylıkla monte edilebilir. (NVT 3900)</li> <li>The board and flashers can be mounted easily with apparatus. (NVT 3900)</li> </ul>	



NVT 3070	
PVC TRAFİK KONİSİ 70 CM (REFLEKTİFSİZ)	PVC CONE 70 CM
Teknik Özellikler / Technical Specifications	
Malzeme / Material	PVC
Ölçüler / Dimensions	40 x 75 cm
Renk / Color	Kırmızı / Red
Ağırlık / Weight	2,4 kg ± 0,1 kg
<ul style="list-style-type: none"> <li>Aparat takarak tabela ve flaşörler kolaylıkla monte edilebilir. (NVT 3900)</li> <li>The board and flashers can be mounted easily with apparatus. (NVT 3900)</li> </ul>	



NVT 3170	
PVC TRAFİK KONİSİ 70 CM (TEK REFLEKTİFLİ)	PVC CONE 70 CM (ONE REFLECTIVE)
Teknik Özellikler / Technical Specifications	
Malzeme / Material	PVC
Ölçüler / Dimensions	40 x 75 cm
Renk / Color	Kırmızı / Red
Ağırlık / Weight	2,4 kg ± 0,1 kg
<ul style="list-style-type: none"> <li>Aparat takarak tabela ve flaşörler kolaylıkla monte edilebilir. (NVT 3900)</li> <li>The board and flashers can be mounted easily with apparatus. (NVT 3900)</li> </ul>	



NVT 3270	
PVC TRAFİK KONİSİ 70 CM (ÇİFT REFLEKTİFLİ)	PVC CONE 70 CM (TWO REFLECTIVE)
Teknik Özellikler / Technical Specifications	
Malzeme / Material	PVC
Ölçüler / Dimensions	40 x 75 cm
Renk / Color	Kırmızı / Red
Ağırlık / Weight	2,4 kg ± 0,1 kg
<ul style="list-style-type: none"> <li>Aparat takarak tabela ve flaşörler kolaylıkla monte edilebilir. (NVT 3900)</li> <li>The board and flashers can be mounted easily with apparatus. (NVT 3900)</li> </ul>	



NVT 3000	
PVC AMERİKAN KONİ 70 CM (REFLEKTİFSİZ)	PVC AMERICAN CONE 70 CM
Teknik Özellikler / Technical Specifications	
Malzeme / Material	PVC
Ölçüler / Dimensions	37 x 72 cm
Renk / Color	Turuncu / Orange
Ağırlık / Weight	3,250 kg ± 0,2 kg
<ul style="list-style-type: none"> <li>Aparat takarak tabela ve flaşörler kolaylıkla monte edilebilir. (NVT 3900)</li> <li>The board and flashers can be mounted easily with apparatus. (NVT 3900)</li> </ul>	



NVT 3100	
PVC AMERİKAN KONİ 70 CM (TEK REFLEKTİFLİ)	PVC AMERICAN CONE 70 CM (ONE REFLECTIVE)
Teknik Özellikler / Technical Specifications	
Malzeme / Material	PVC
Ölçüler / Dimensions	37 x 72 cm
Renk / Color	Turuncu / Orange
Ağırlık / Weight	3,250 kg ± 0,2 kg
<ul style="list-style-type: none"> <li>Aparat takarak tabela ve flaşörler kolaylıkla monte edilebilir. (NVT 3900)</li> <li>The board and flashers can be mounted easily with apparatus. (NVT 3900)</li> </ul>	



NVT 3200	
PVC AMERİKAN KONİ 70 CM (ÇİFT REFLEKTİFLİ)	PVC AMERICAN CONE 70 CM (TWO REFLECTIVE)
Teknik Özellikler / Technical Specifications	
Malzeme / Material	PVC
Ölçüler / Dimensions	37 x 72 cm
Renk / Color	Turuncu / Orange
Ağırlık / Weight	3,250 kg ± 0,2 kg
<ul style="list-style-type: none"> <li>Aparat takarak tabela ve flaşörler kolaylıkla monte edilebilir. (NVT 3900)</li> <li>The board and flashers can be mounted easily with apparatus. (NVT 3900)</li> </ul>	



NVT 3075	
PVC TRAFİK KONİSİ (2 KG) 75 CM (REFLEKTİFSİZ)	PVC CONE 75 CM
Teknik Özellikler / Technical Specifications	
Malzeme / Material	PVC
Ölçüler / Dimensions	43 x 75 cm
Renk / Color	Turuncu / Orange
Ağırlık / Weight	2 kg ± 0,2 kg
<ul style="list-style-type: none"> <li>Aparat takarak tabela ve flaşörler kolaylıkla monte edilebilir. (NVT 3900)</li> <li>The board and flashers can be mounted easily with apparatus. (NVT 3900)</li> </ul>	



NVT 3175	
PVC TRAFİK KONİSİ (2 KG) 75 CM (TEK REFLEKTİFLİ)	PVC CONE 75 CM (ONE REFLECTIVE)
Teknik Özellikler / Technical Specifications	
Malzeme / Material	PVC
Ölçüler / Dimensions	43 x 75 cm
Renk / Color	Turuncu / Orange
Ağırlık / Weight	2 kg ± 0,2 kg
<ul style="list-style-type: none"> <li>Aparat takarak tabela ve flaşörler kolaylıkla monte edilebilir. (NVT 3900)</li> <li>The board and flashers can be mounted easily with apparatus. (NVT 3900)</li> </ul>	



NVT 3275	
PVC TRAFİK KONİSİ (2 KG) 75 CM (ÇİFT REFLEKTİFLİ)	PVC CONE 75 CM (TWO REFLECTIVE)
Teknik Özellikler / Technical Specifications	
Malzeme / Material	PVC
Ölçüler / Dimensions	43 x 75 cm
Renk / Color	Turuncu / Orange
Ağırlık / Weight	2 kg ± 0,2 kg
<ul style="list-style-type: none"> <li>Aparat takarak tabela ve flaşörler kolaylıkla monte edilebilir. (NVT 3900)</li> <li>The board and flashers can be mounted easily with apparatus. (NVT 3900)</li> </ul>	



NVT 3076	
PVC TRAFİK KONİSİ (3 KG) 75 CM (REFLEKTİFSİZ)	PVC CONE 75 CM
Teknik Özellikler / Technical Specifications	
Malzeme / Material	PVC
Ölçüler / Dimensions	43 x 75 cm
Renk / Color	Turuncu / Orange
Ağırlık / Weight	3 kg ± 0,2 kg
<ul style="list-style-type: none"> <li>Aparat takarak tabela ve flaşörler kolaylıkla monte edilebilir. (NVT 3900)</li> <li>The board and flashers can be mounted easily with apparatus. (NVT 3900)</li> </ul>	



NVT 3176	
PVC TRAFİK KONİSİ (3 KG) 75 CM (TEK REFLEKTİFLİ)	PVC CONE 75 CM (ONE REFLECTIVE)
Teknik Özellikler / Technical Specifications	
Malzeme / Material	PVC
Ölçüler / Dimensions	43 x 75 cm
Renk / Color	Turuncu / Orange
Ağırlık / Weight	3 kg ± 0,2 kg
<ul style="list-style-type: none"> <li>Aparat takarak tabela ve flaşörler kolaylıkla monte edilebilir. (NVT 3900)</li> <li>The board and flashers can be mounted easily with apparatus. (NVT 3900)</li> </ul>	



NVT 3276	
PVC TRAFİK KONİSİ (3 KG) 75 CM (ÇİFT REFLEKTİFLİ)	PVC CONE 75 CM (TWO REFLECTIVE)
Teknik Özellikler / Technical Specifications	
Malzeme / Material	PVC
Ölçüler / Dimensions	43 x 75 cm
Renk / Color	Turuncu / Orange
Ağırlık / Weight	3 kg ± 0,2 kg
<ul style="list-style-type: none"> <li>Aparat takarak tabela ve flaşörler kolaylıkla monte edilebilir. (NVT 3900)</li> <li>The board and flashers can be mounted easily with apparatus. (NVT 3900)</li> </ul>	



NVT 3090	
PVC TRAFİK KONİSİ 90 CM (REFLEKTİFSİZ)	PVC CONE 90 CM
Teknik Özellikler / Technical Specifications	
Malzeme / Material	PVC
Ölçüler / Dimensions	43 x 90 cm
Renk / Color	Turuncu / Orange
Ağırlık / Weight	3,150 kg ± 0,3 kg
<ul style="list-style-type: none"> <li>Aparat takarak tabela ve flaşörler kolaylıkla monte edilebilir. (NVT 3900)</li> <li>The board and flashers can be mounted easily with apparatus. (NVT 3900)</li> </ul>	



NVT 3190	
PVC TRAFİK KONİSİ 90 CM (TEK REFLEKTİFLİ)	PVC CONE 90 CM (ONE REFLECTIVE)
Teknik Özellikler / Technical Specifications	
Malzeme / Material	PVC
Ölçüler / Dimensions	43 x 90 cm
Renk / Color	Turuncu / Orange
Ağırlık / Weight	3,150 kg ± 0,3 kg
<ul style="list-style-type: none"> <li>Aparat takarak tabela ve flaşörler kolaylıkla monte edilebilir. (NVT 3900)</li> <li>The board and flashers can be mounted easily with apparatus. (NVT 3900)</li> </ul>	



NVT 3290	
PVC AMERİKAN KONİ 70 CM (ÇİFT REFLEKTİFLİ)	PVC AMERICAN CONE 70 CM (TWO REFLECTIVE)
Teknik Özellikler / Technical Specifications	
Malzeme / Material	PVC
Ölçüler / Dimensions	43 x 90 cm
Renk / Color	Turuncu / Orange
Ağırlık / Weight	3,150 kg ± 0,3 kg
<ul style="list-style-type: none"> <li>Aparat takarak tabela ve flaşörler kolaylıkla monte edilebilir. (NVT 3900)</li> <li>The board and flashers can be mounted easily with apparatus. (NVT 3900)</li> </ul>	



NVT 3500	
EKONOMİK TRAFİK VE REKLAM KONİSİ 50 CM	ECONOMIC TRAFFIC AND ADVERTISING CONE 50 CM
Teknik Özellikler / Technical Specifications	
Malzeme / Material	PVC
Ölçüler / Dimensions	50 cm
Renk / Color	Kırmızı / Red
Ağırlık / Weight	640 gr ± 0,2 kg



NVT 3550	
TRAFİK VE REKLAM KONİSİ 50 CM (KAUÇUK TABANLI)	TRAFFIC AND ADVERTISING CONE 50 CM (RUBBER BASE)
Teknik Özellikler / Technical Specifications	
Malzeme / Material	HDPE + Kauçuk (Rubber)
Ölçüler / Dimensions	50 cm
Renk / Color	Kırmızı, Siyah / Red, Black
Ağırlık / Weight	3 kg ± 0,1 kg
<ul style="list-style-type: none"> <li>Aparat gerektirmeden tabela ve flaşörler kolaylıkla monte edilebilir.</li> <li>The board and flashers can be mounted without any apparatus.</li> </ul>	



NVT 3575	
TRAFİK VE REKLAM KONİSİ 75 CM (KAUÇUK TABANLI)	TRAFFIC AND ADVERTISING CONE 75 CM (RUBBER BASE)
Teknik Özellikler / Technical Specifications	
Malzeme / Material	HDPE + Kauçuk (Rubber)
Ölçüler / Dimensions	75 cm
Renk / Color	Kırmızı, Siyah / Red, Black
Ağırlık / Weight	3 kg ± 0,1 kg
<ul style="list-style-type: none"> <li>Aparat gerektirmeden tabela ve flaşörler kolaylıkla monte edilebilir.</li> <li>The board and flashers can be mounted without any apparatus.</li> </ul>	



NVT 3590	
TRAFİK VE REKLAM KONİSİ 90 CM (KAUÇUK TABANLI)	TRAFFIC AND ADVERTISING CONE 90 CM (RUBBER BASE)
Teknik Özellikler / Technical Specifications	
Malzeme / Material	HDPE + Kauçuk (Rubber)
Ölçüler / Dimensions	90 cm
Renk / Color	Kırmızı, Siyah / Red, Black
Ağırlık / Weight	3 kg ± 0,1 kg
<ul style="list-style-type: none"> <li>Aparat gerektirmeden tabela ve flaşörler kolaylıkla monte edilebilir.</li> <li>The board and flashers can be mounted without any apparatus.</li> </ul>	



NVT 3700	
KEDİ GÖZLÜ KONİ	CAT EYE CONE
Teknik Özellikler / Technical Specifications	
Malzeme / Material	PP
Ölçüler / Dimensions	37 x 60 cm
Ağırlık / Weight	7 kg



NVT 3800	
KONİ BARİKATI	CONE BAR
Teknik Özellikler / Technical Specifications	
Uzunluk / Length	120 x 190 cm
Kalınlık / Dimensions	3,4 cm
Renk / Color	Kırmızı, Beyaz - Sarı, Siyah Red, White - Yellow, Black
Ağırlık / Weight	400 gr



NVT 3900	
KONİ LEVHA TAKMA APARATI	CONE APPARATUS
Teknik Özellikler / Technical Specifications	
Malzeme / Material	PVC
Ölçüler / Dimensions	7 x 10,5 cm
Renk / Color	Siyah / Black
Ağırlık / Weight	60 gr



NVT 3950	
KONİ AĞIRLIĞI	CONE BASE
Teknik Özellikler / Technical Specifications	
Malzeme / Material	PVC
Ölçüler / Dimensions	38,5 x 90 cm 38,5 x 75 cm
Ağırlık / Weight	2,8 kg

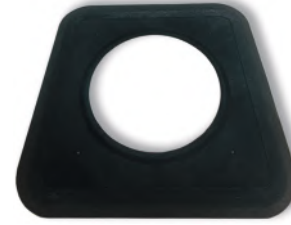

NVT 4010	
DİKME DUBA	PARKING POST
Teknik Özellikler / Technical Specifications	
Malzeme / Material	PP
Çap / Diameter	40 cm
Yükseklik / Height	20 cm
Renk / Color	Şapka Beyaz, Gövde Kırmızı, Taban Siyah Hat White, Body Red, Base Black
Ağırlık / Weight	6 kg ± 0,5 kg
<ul style="list-style-type: none"> <li>Aparat gerektirmeden tabela ve flaşörler kolaylıkla monte edilebilir.</li> <li>The board and flashers can be mounted without any apparatus.</li> </ul>	



NVT 4020	
DUBALI REKLAM VE UYARI DİKMESİ	PARKING POST WITH BOLLARD
Teknik Özellikler / Technical Specifications	
Malzeme / Material	PP
Çap / Diameter	10 cm
Yükseklik / Height	90 cm
Renk / Color	Şapka Beyaz, Gövde Kırmızı, Taban Siyah Hat White, Body Red, Base Black
Ağırlık / Weight	6 kg ± 0,5 kg
<ul style="list-style-type: none"> <li>Aparat gerektirmeden tabela ve flaşörler kolaylıkla monte edilebilir.</li> <li>The board and flashers can be mounted without any apparatus.</li> </ul>	



NVT 4030	
DUBALI REKLAM UYARI VE YÖN TABELASI	PARKING POST WITH WARNING BOARD
Teknik Özellikler / Technical Specifications	
Malzeme / Material	PP
Çap / Diameter	40 cm
Yükseklik / Height	90 cm
Renk / Color	Şapka Beyaz, Gövde Kırmızı, Taban Siyah Hat White, Body Red, Base Black
Ağırlık / Weight	6 kg ± 0,5 kg
<ul style="list-style-type: none"> <li>Aparat gerektirmeden tabela ve flaşörler kolaylıkla monte edilebilir.</li> <li>The board and flashers can be mounted without any apparatus.</li> </ul>	



NVT 4050	
KISA DİKME MICIR	WARNING POST ( GRAVEL BASE )
Teknik Özellikler / Technical Specifications	
Malzeme / Material	HDPE + PP
Çap / Diameter	120 mm
Yükseklik / Height	65 cm
Renk / Color	Şapka Beyaz, Gövde Kırmızı, Taban Siyah Hat White, Body Red, Base Black
Ağırlık / Weight	5,4 kg ± 0,5 kg
<ul style="list-style-type: none"> <li>Aparat takarak tabela ve flaşörler kolaylıkla monte edilebilir. (NVT 3900)</li> <li>The board and flashers can be mounted easily with apparatus. (NVT 3900)</li> </ul>	



NVT 4060	
DUBALI UYARI DİKME 60 MM	WARNING POST 60 MM ( GRAVEL BASE )
Teknik Özellikler / Technical Specifications	
Malzeme / Material	HDPE + PP
Çap / Diameter	60 mm
Yükseklik / Height	100 cm
Renk / Color	Şapka Beyaz, Gövde Kırmızı, Taban Siyah Hat White, Body Red, Base Black
Ağırlık / Weight	5,810 kg ± 0,5 kg
<ul style="list-style-type: none"> <li>Aparat gerektirmeden tabela ve flaşörler kolaylıkla monte edilebilir.</li> <li>The board and flashers can be mounted without any apparatus.</li> </ul>	



NVT 4090	
DUBALI UYARI DİKME 90 MM	WARNING POST 90 MM ( GRAVEL BASE )
Teknik Özellikler / Technical Specifications	
Malzeme / Material	HDPE + PP
Çap / Diameter	90 mm
Yükseklik / Height	100 cm
Renk / Color	Şapka Beyaz, Gövde Kırmızı, Taban Siyah Hat White, Body Red, Base Black
Ağırlık / Weight	4,1 kg ± 0,5 kg
<ul style="list-style-type: none"> <li>Aparat gerektirmeden tabela ve flaşörler kolaylıkla monte edilebilir.</li> <li>The board and flashers can be mounted without any apparatus.</li> </ul>	



NVT 4120	
DUBALI UYARI DİKME 120 MM	WARNING POST 120 MM ( GRAVEL BASE )
Teknik Özellikler / Technical Specifications	
Malzeme / Material	HDPE + PP
Çap / Diameter	110 mm
Yükseklik / Height	120 cm
Renk / Color	Şapka Beyaz, Gövde Kırmızı, Taban Siyah Hat White, Body Red, Base Black
Ağırlık / Weight	8,3 kg ± 0,5 kg
<ul style="list-style-type: none"> <li>Aparat takarak tabela ve flaşörler kolaylıkla monte edilebilir. (NVT 3900)</li> <li>The board and flashers can be mounted easily with apparatus. (NVT 3900)</li> </ul>	



NVT 4055	
KISA DİKME KAUÇUK	WARNING POST ( RUBBER BASE )
Teknik Özellikler / Technical Specifications	
Malzeme / Material	HDPE + Kauçuk Taban (Rubber Base)
Çap / Diameter	110 mm
Yükseklik / Height	65 cm
Renk / Color	Şapka Beyaz, Gövde Kırmızı, Taban Siyah Hat White, Body Red, Base Black
Ağırlık / Weight	5,4 kg ± 0,5 kg
<ul style="list-style-type: none"> <li>Aparat takarak tabela ve flaşörler kolaylıkla monte edilebilir. (NVT 3900)</li> <li>The board and flashers can be mounted easily with apparatus. (NVT 3900)</li> </ul>	



NVT 4065	
DUBALI UYARI DİKME 60 MM KAUÇUK TABAN	WARNING POST 60 MM ( RUBBER BASE )
Teknik Özellikler / Technical Specifications	
Malzeme / Material	HDPE + PP
Çap / Diameter	60 mm
Yükseklik / Height	100 cm
Renk / Color	Şapka Beyaz, Gövde Kırmızı, Taban Siyah Hat White, Body Red, Base Black
Ağırlık / Weight	6,850 kg ± 0,5 kg
<ul style="list-style-type: none"> <li>Aparat gerektirmeden tabela ve flaşörler kolaylıkla monte edilebilir.</li> <li>The board and flashers can be mounted without any apparatus.</li> </ul>	



NVT 4095	
DUBALI UYARI DİKME 90 MM KAUÇUK TABAN	WARNING POST 90 MM ( GRAVEL BASE )
Teknik Özellikler / Technical Specifications	
Malzeme / Material	HDPE + PP
Çap / Diameter	90 mm
Yükseklik / Height	100 cm
Renk / Color	Şapka Beyaz, Gövde Kırmızı, Taban Siyah Hat White, Body Red, Base Black
Ağırlık / Weight	8 ± 0,5 kg
<ul style="list-style-type: none"> <li>Aparat gerektirmeden tabela ve flaşörler kolaylıkla monte edilebilir.</li> <li>The board and flashers can be mounted without any apparatus.</li> </ul>	



NVT 4125	
DUBALI UYARI DİKME 120 MM KAUÇUK TABAN	WARNING POST 90 MM ( GRAVEL BASE )
Teknik Özellikler / Technical Specifications	
Malzeme / Material	HDPE + PP
Çap / Diameter	110 mm
Yükseklik / Height	120 cm
Renk / Color	Şapka Beyaz, Gövde Kırmızı, Taban Siyah Hat White, Body Red, Base Black
Ağırlık / Weight	9,050 kg ± 0,5 kg
<ul style="list-style-type: none"> <li>Aparat takarak tabela ve flaşörler kolaylıkla monte edilebilir. (NVT 3900)</li> <li>The board and flashers can be mounted easily with apparatus. (NVT 3900)</li> </ul>	



NVT 4200	
KAYGAN ZEMİN TABELASI (BASKISIZ)	WET FLOOR BOARD ( PRINTLESS )
Teknik Özellikler / Technical Specifications	
Yükseklik / Height	65 cm
Genişlik / Width	30 cm
Renk / Color	Sarı Üzerine Serigrafi Baskı Yellow on Screen Printing
Özellik / Speciality	Üzerinde 8 adet Kedi Gözü Mevcuttur. On 8 pieces Round Cat's Eye Available
Ağırlık / Weight	810 gr



NVT 4201	
KAYGAN ZEMİN TABELASI	WET FLOOR BOARD
Teknik Özellikler / Technical Specifications	
Yükseklik / Height	65 cm
Genişlik / Width	30 cm
Renk / Color	Sarı Üzerine Serigrafi Baskı Yellow on Screen Printing
Özellik / Speciality	Üzerinde 8 adet Kedi Gözü Mevcuttur. On 8 pieces Round Cat's Eye Available
Ağırlık / Weight	810 gr



NVT 4500	
A TABELA GRİ	A BOARD GREY
Teknik Özellikler / Technical Specifications	
Malzeme / Material	HDPE
Ölçüler / Dimensions	50 x 93 cm
Reklam Alanı / Advertising	48 x 74 cm
Ağırlık / Weight	5 kg ± 0,5 kg
Dolu Ağırlık / Full Weight	20 kg
Renk / Color	Gri / Grey



NVT 4505	
A TABELA KIRMIZI	A BOARD RED
Teknik Özellikler / Technical Specifications	
Malzeme / Material	HDPE
Ölçüler / Dimensions	50 x 93 cm
Reklam Alanı / Advertising	48 x 74 cm
Ağırlık / Weight	5 kg ± 0,5 kg
Dolu Ağırlık / Full Weight	20 kg
Renk / Color	Kırmızı / Red



NVT 4510	
REKLAM DUBASI 33 x 38 CM	ADVERTISING BOLLARD
Teknik Özellikler / Technical Specifications	
Malzeme / Material	HDPE
Reklam Alanı / Advertising	33 x 38 cm
Boy / High	113 cm
Boş Ağırlık / Empty Weight	2 kg
Dolu Ağırlık / Full Weight	9,5 kg



NVT 4515	
REKLAM DUBASI 45 x 50 CM	ADVERTISING BOLLARD
Teknik Özellikler / Technical Specifications	
Malzeme / Material	HDPE
Reklam Alanı / Advertising	45 x 50 cm
Boy / Hight	125 cm
Boş Ağırlık / Empty Weight	2,5 kg
Dolu Ağırlık / Full Weight	10 kg



NVT 4520	
REKLAM DUBASI 41 x 74 CM GRİ	ADVERTISING BOLLARD GREY
Teknik Özellikler / Technical Specifications	
Malzeme / Material	HDPE
Reklam Alanı / Advertising	41 x 74 cm
Boy / Hight	105 cm
Boş Ağırlık / Empty Weight	3 kg
Dolu Ağırlık / Full Weight	10 kg
Renk / Color	Gri / Grey



NVT 4525	
REKLAM DUBASI 41 x 74 CM KIRMIZI	ADVERTISING BOLLARD RED
Teknik Özellikler / Technical Specifications	
Malzeme / Material	HDPE
Reklam Alanı / Advertising	41 x 74 cm
Boy / Hight	105 cm
Boş Ağırlık / Empty Weight	3 kg
Dolu Ağırlık / Full Weight	10 kg
Renk / Color	Kırmızı / Red



NVT 4530	
REKLAM DUBASI GRİ	ADVERTISING BOLLARD GREY
Teknik Özellikler / Technical Specifications	
Malzeme / Material	HDPE
Reklam Alanı / Advertising	45 x 75 cm
Boy / Hight	105 cm
Boş Ağırlık / Empty Weight	4 kg
Dolu Ağırlık / Full Weight	12 kg
Renk / Color	Gri / Grey



NVT 4535	
REKLAM DUBASI KIRMIZI	ADVERTISING BOLLARD RED
Teknik Özellikler / Technical Specifications	
Malzeme / Material	HDPE
Reklam Alanı / Advertising	45 x 75 cm
Boy / Hight	105 cm
Boş Ağırlık / Empty Weight	4 kg
Dolu Ağırlık / Full Weight	12 kg
Renk / Color	Kırmızı / Red



NVT 4540	
PANO REKLAM DUBASI GRİ	ADVERTISING BOLLARD GREY
Teknik Özellikler / Technical Specifications	
Malzeme / Material	HDPE
Reklam Alanı / Advertising	50 x 90 cm
Boy / Hight	130 cm
Boş Ağırlık / Empty Weight	3,3 kg
Dolu Ağırlık / Full Weight	24 kg
Renk / Color	Gri / Grey



NVT 4545	
PANO REKLAM DUBASI KIRMIZI	ADVERTISING BOLLARD RED
Teknik Özellikler / Technical Specifications	
Malzeme / Material	HDPE
Reklam Alanı / Advertising	50 x 90 cm
Boy / Hight	130 cm
Boş Ağırlık / Empty Weight	3,3 kg
Dolu Ağırlık / Full Weight	24 kg
Renk / Color	Kırmızı / Red



NVT 5000	
HİSSEDİLEBİLİR YÜRÜME YÜZEYİ (KILAVUZ TİP)	TACTILE SURFACE (GUIDE TYPE)
Teknik Özellikler / Technical Specifications	
Malzeme / Material	TPU
Ölçüler / Dimensions	40 x 40 x 0,8 cm
Renk / Color	Sarı / Yellow
Ağırlık / Weight	660 gr



NVT 5001	
HİSSEDİLEBİLİR YÜRÜME YÜZEYİ (KILAVUZ TİP)	TACTILE SURFACE (GUIDE TYPE)
Teknik Özellikler / Technical Specifications	
Malzeme / Material	TPU
Ölçüler / Dimensions	40 x 40 x 0,5 cm 6 Adet (6 Pieces)
Renk / Color	Sarı / Yellow
Ağırlık / Weight	310 gr

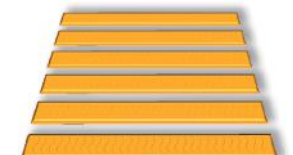

NVT 5005	
HİSSEDİLEBİLİR YÜRÜME YÜZEYİ (UYARICI TİP)	TACTILE SURFACE (STIMULANT TYPE)
Teknik Özellikler / Technical Specifications	
Malzeme / Material	TPU
Ölçüler / Dimensions	40 x 40 x 0,8 cm
Renk / Color	Sarı / Yellow
Ağırlık / Weight	560 gr



NVT 5006	
HİSSEDİLEBİLİR YÜRÜME YÜZEYİ (UYARICI TİP)	TACTILE SURFACE (STIMULANT TYPE)
Teknik Özellikler / Technical Specifications	
Malzeme / Material	TPU
Ölçüler / Dimensions	40 x 40 x 0,5 cm 49 Adet (49 Pieces)
Renk / Color	Sarı / Yellow
Ağırlık / Weight	120 gr

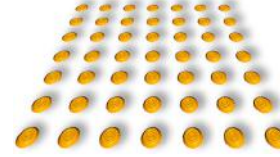

NVT 5110	
OVAL YOL BUTONU	OVAL ROAD STUD
Teknik Özellikler / Technical Specifications	
Malzeme / Material	PPC
Ölçüler / Dimensions	12 x 18 x 2,8 cm
Renk / Color	Sarı / Yellow
Ağırlık / Weight	170 gr
Reflektör / Reflector	4 Adet Kedi Gözü Reflektör. (4 Cat's Eye Reflector)



NVT 5120	
KLASİK YOL BUTONU	CLASSIC ROAD STUD
Teknik Özellikler / Technical Specifications	
Malzeme / Material	PPC
Ölçüler / Dimensions	13 x 15 x 3 cm
Renk / Color	Sarı / Yellow
Ağırlık / Weight	180 gr
Reflektör / Reflector	4 Adet Kedi Gözü Reflektör. (4 Cat's Eye Reflector)



NVT 5130	
REFLEKTİFLİ YOL BUTONU	REFLECTIVE ROAD STUD
Teknik Özellikler / Technical Specifications	
Malzeme / Material	TPU
Ölçüler / Dimensions	10 x 10 cm
Renk / Color	Sarı / Yellow
Ağırlık / Weight	120 gr
Montaj / Assembly	Dübel - Vida (Dowel - Screw)



NVT 5140	
CAM MERCEKLİ YOL BUTONU	GLASS BEADS ROAD STUD
Teknik Özellikler / Technical Specifications	
Malzeme / Material	TPU
Ölçüler / Dimensions	22 x 12 x 2,8 cm
Renk / Color	Sarı / Yellow
Ağırlık / Weight	230 gr



NVT 5150	
GÜNEŞ ENERJİLİ YOL BUTONU	SOLAR ROAD STUD
Teknik Özellikler / Technical Specifications	
Malzeme / Material	TPU
Ölçüler / Dimensions	14,8 x 12 x 2,8 cm
Renk / Color	Kırmızı / Red
Ağırlık / Weight	420 gr



NVT 5160	
METAL YOL BUTONU	ALUMINIUM ROAD STUD
Teknik Özellikler / Technical Specifications	
Malzeme / Material	Al
Ölçüler / Dimensions	12 x 12 x 2,8 cm
Renk / Color	Grİ / Grey
Ağırlık / Weight	330 gr



NVT 5200	
OVAL YOL KASISI	PLASTIC SPEED RAMP
Teknik Özellikler / Technical Specifications	
Malzeme / Material	PPC
Ölçüler / Dimensions	30 x 33 x 4 cm
Renk / Color	Sarı, Siyah / Yellow, Black
Ağırlık / Weight	1,230 kg ± 0,1 kg
Reflektör / Reflector	6 Adet Kedi Gözü Reflektör. (6 Cat's Eye Reflector)



NVT 5201	
OVAL YOL KASISI BAŞLIĞI	PLASTIC SPEED RAMP END
Teknik Özellikler / Technical Specifications	
Malzeme / Material	PPC
Ölçüler / Dimensions	10 x 30 x 4 cm
Renk / Color	Sarı, Siyah / Yellow, Black
Ağırlık / Weight	200 gr



NVT 5250	
YÜKSEK ETKİLİ KASIS	PLASTIC HIGH SPEED RAMP
Teknik Özellikler / Technical Specifications	
Malzeme / Material	PPC
Ölçüler / Dimensions	25 x 35 x 5 cm
Renk / Color	Sarı, Siyah / Yellow, Black
Ağırlık / Weight	1,3 kg



NVT 5251	
YÜKSEK ETKİLİ KASIS KAPAĞI	PLASTIC HIGH SPEED RAMP END
Teknik Özellikler / Technical Specifications	
Malzeme / Material	PPC
Ölçüler / Dimensions	25 x 10 x 5 cm
Renk / Color	Sarı, Siyah / Yellow, Black
Ağırlık / Weight	360 gr





NVT 5330	
30x33 REFLEKTÖRLÜ KAUÇUK KASIS	30x33 RUBBER SPEED RAMP
Teknik Özellikler / Technical Specifications	
Malzeme / Material	NR/SBR (Yüksek Mukavemetli Kauçuk) (High Strength Rubber)
Ölçüler / Dimensions	30 x 33 x 4 cm
Renk / Color	Siyah / Black
Ağırlık / Weight	3,5 kg ± 0,1 kg
Reflektör / Reflector	2 Adet Paralel Yapıştırılmış Cam Kürecikli Reflektör Bant 2 Grain Spherulitic Parallel Glued Glass Reflector Tape
Not / Note	1 Metre Kasis 3 Adetten Oluşmaktadır. 1 Meter Ramps Consists of 3 Pieces.



NVT 5331	
30x15 KASIS BAŞLIĞI	30x15 RUBBER SPEED RAMP END
Teknik Özellikler / Technical Specifications	
Malzeme / Material	NR/SBR (Yüksek Mukavemetli Kauçuk) (High Strength Rubber)
Ölçüler / Dimensions	30 x 15 x 4 cm
Renk / Color	Siyah / Black
Ağırlık / Weight	1,5 kg ± 0,1 kg



NVT 5350	
30x50 KAUÇUK KASIS	30x50 RUBBER SPEED RAMP
Teknik Özellikler / Technical Specifications	
Malzeme / Material	NR/SBR (Yüksek Mukavemetli Kauçuk) (High Strength Rubber)
Ölçüler / Dimensions	50 x 30 x 4,5 cm
Renk / Color	Siyah, Sarı / Black, Yellow
Ağırlık / Weight	6 kg ± 0,1 kg
Reflektör / Reflector	2 Adet Paralel Yapıştırılmış Cam Kürecikli Reflektör Bant 2 Grain Spherulitic Parallel Glued Glass Reflector Tape
Not / Note	1 Metre Kasis 3 Adetten Oluşmaktadır. 1 Meter Ramps Consists of 3 Pieces.



NVT 5351	
30x15 KASIS BAŞLIĞI	30x15 RUBBER SPEED RAMP END
Teknik Özellikler / Technical Specifications	
Malzeme / Material	NR/SBR (Yüksek Mukavemetli Kauçuk) (High Strength Rubber)
Ölçüler / Dimensions	30 x 15 x 4,5 cm
Renk / Color	Siyah, Sarı / Black, Yellow
Ağırlık / Weight	1,5 kg ± 0,1 kg



NVT 5450	
40x50 KAUÇUK KASIS	40x50 RUBBER SPEED RAMP
Teknik Özellikler / Technical Specifications	
Malzeme / Material	NR/SBR (Yüksek Mukavemetli Kauçuk) (High Strength Rubber)
Ölçüler / Dimensions	40 x 50 x 4,5 cm
Renk / Color	Siyah / Black
Ağırlık / Weight	7 kg ± 0,1 kg
Reflektör / Reflector	2 Adet Paralel Yapıştırılmış Cam Kürecikli Reflektör Bant 2 Grain Spherulitic Parallel Glued Glass Reflector Tape
Not / Note	1 Metre Kasis 3 Adetten Oluşmaktadır. 1 Meter Ramps Consists of 3 Pieces.



NVT 5451	
40x30 KASIS BAŞLIĞI	40x30 RUBBER SPEED RAMP END
Teknik Özellikler / Technical Specifications	
Malzeme / Material	NR/SBR (Yüksek Mukavemetli Kauçuk) (High Strength Rubber)
Ölçüler / Dimensions	40 x 30 x 4,5 cm
Renk / Color	Siyah / Black
Ağırlık / Weight	3,5 kg ± 0,1 kg



NVT 5455	
40x50 KAUÇUK KASIS	40x50 RUBBER SPEED RAMP
Teknik Özellikler / Technical Specifications	
Malzeme / Material	Kauçuk (Rubber)
Ölçüler / Dimensions	40 x 50 x 5 cm
Renk / Color	Siyah, Sarı / Black, Yellow
Ağırlık / Weight	7,5 kg ± 0,1 kg



NVT 5456	
40x25 KASIS BAŞLIĞI	40x25 RUBBER SPEED RAMP END
Teknik Özellikler / Technical Specifications	
Malzeme / Material	Kauçuk (Rubber)
Ölçüler / Dimensions	40 x 25 x 5 cm
Renk / Color	Siyah, Sarı / Black, Yellow
Ağırlık / Weight	2,30 kg ± 0,1 kg



NVT 5540	
40x50 KEDİ GÖZLÜ KASIS	40x50 RUBBER SPEED RAMP
Teknik Özellikler / Technical Specifications	
Malzeme / Material	NR/SBR (Yüksek Mukavemetli Kauçuk) (High Strength Rubber)
Ölçüler / Dimensions	40 x 50 x 5 cm
Renk / Color	Siyah, Sarı / Black, Yellow
Ağırlık / Weight	7 kg ± 0,1 kg

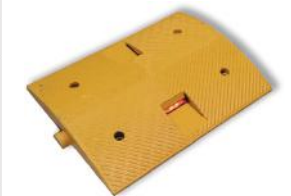

NVT 5541	
40x15 KEDİ GÖZLÜ KASIS BAŞLIĞI	40x15 RUBBER SPEED RAMP END
Teknik Özellikler / Technical Specifications	
Malzeme / Material	NR/SBR (Yüksek Mukavemetli Kauçuk) (High Strength Rubber)
Ölçüler / Dimensions	40 x 15 x 4,5 cm
Renk / Color	Siyah, Sarı / Black, Yellow
Ağırlık / Weight	1,5 kg ± 0,1 kg



NVT 5545	
40x50 4 REFLEKTÖRLÜ KASIS	40x50 RUBBER SPEED RAMP
Teknik Özellikler / Technical Specifications	
Malzeme / Material	NR/SBR (Yüksek Mukavemetli Kauçuk) (High Strength Rubber)
Ölçüler / Dimensions	40 x 50 x 4,5 cm
Renk / Color	Siyah / Black
Ağırlık / Weight	7 kg ± 0,1 kg
Reflektör / Reflector	4 Adet Paralel Yapıştırılmış Cam Kürecikli Reflektör Bant 4 Grain Spherulitic Parallel Glued Glass Reflector Tape
Not / Note	1 Metre Kasis 2 Adetten Oluşmaktadır. 1 Meter Ramps Consists of 2 Pieces.



NVT 5546	
40x30 4 REFLEKTÖRLÜ KASIS KAPAĞI	40x30 RUBBER SPEED RAMP END
Teknik Özellikler / Technical Specifications	
Malzeme / Material	NR/SBR (Yüksek Mukavemetli Kauçuk) (High Strength Rubber)
Ölçüler / Dimensions	40 x 30 x 4,5 cm
Renk / Color	Siyah / Black
Ağırlık / Weight	3,5 kg ± 0,1 kg



NVT 5550	
40x50 4 REFLEKTÖRLÜ KASIS	40x50 RUBBER SPEED RAMP
Teknik Özellikler / Technical Specifications	
Malzeme / Material	NR/SBR (Yüksek Mukavemetli Kauçuk) (High Strength Rubber)
Ölçüler / Dimensions	50 x 50 x 4,5 cm
Renk / Color	Siyah / Black
Ağırlık / Weight	8 kg ± 0,1 kg
Reflektör / Reflector	4 Adet Paralel Yapıştırılmış Cam Kürecikli Reflektör Bant 4 Grain Spherulitic Parallel Glued Glass Reflector Tape
Not / Note	1 Metre Kasis 2 Adetten Oluşmaktadır. 1 Meter Ramps Consists of 2 Pieces.



NVT 5551	
40x30 4 REFLEKTÖRLÜ KASIS KAPAĞI	40x30 RUBBER SPEED RAMP END
Teknik Özellikler / Technical Specifications	
Malzeme / Material	NR/SBR (Yüksek Mukavemetli Kauçuk) (High Strength Rubber)
Ölçüler / Dimensions	50 x 30 x 4,5 cm
Renk / Color	Siyah, Sarı / Black, Yellow
Ağırlık / Weight	3 kg ± 0,1 kg



NVT 5550	
40x50 4 REFLEKTÖRLÜ KASIS	40x50 RUBBER SPEED RAMP
Teknik Özellikler / Technical Specifications	
Malzeme / Material	NR/SBR (Yüksek Mukavemetli Kauçuk) (High Strength Rubber)
Ölçüler / Dimensions	50 x 50 x 4,5 cm
Renk / Color	Siyah / Black
Ağırlık / Weight	8 kg ± 0,1 kg
Reflektör / Reflector	6 Adet Paralel Yapıştırılmış Cam Kürecikli Reflektör Bant 6 Grain Spherulitic Parallel Glued Glass Reflector Tape
Not / Note	1 Metre Kasis 2 Adetten Oluşmaktadır. 1 Meter Ramps Consists of 2 Pieces.

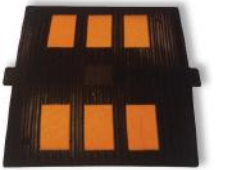

NVT 5551	
60x30 KAÜÇUK KASIS BAŞLIĞI	60x30 RUBBER SPEED RAMP END
Teknik Özellikler / Technical Specifications	
Malzeme / Material	Kauçuk (Rubber)
Ölçüler / Dimensions	60 x 30 x 4,5 cm
Renk / Color	Siyah, Sarı / Black, Yellow
Ağırlık / Weight	4 kg ± 0,1 kg



NVT 5590	
40x50 4 REFLEKTÖRLÜ KAÜÇUK KASIS	40x50 RUBBER SPEED RAMP
Teknik Özellikler / Technical Specifications	
Malzeme / Material	NR/SBR (Yüksek Mukavemetli Kauçuk) (High Strength Rubber)
Ölçüler / Dimensions	90 x 50 x 6 cm
Renk / Color	Siyah / Black
Ağırlık / Weight	21 kg ± 0,1 kg
Reflektör / Reflector	8 Adet Paralel Yapıştırılmış Cam Kürecikli Reflektör Bant 8 Grain Spherulitic Parallel Glued Glass Reflector Tape
Not / Note	1 Metre Kasis 2 Adetten Oluşmaktadır. 1 Meter Ramps Consists of 2 Pieces.



NVT 5591	
90x25 KASIS KAPAĞI	90x25 RUBBER SPEED RAMP END
Teknik Özellikler / Technical Specifications	
Malzeme / Material	NR/SBR (Yüksek Mukavemetli Kauçuk) (High Strength Rubber)
Ölçüler / Dimensions	90 x 25 x 6 cm
Renk / Color	Siyah / Black
Ağırlık / Weight	7,5 kg ± 0,1 kg



NVT 5700	
KAPAN KASIS (ASFALT ÜSTÜ)	IRON SNARE RAMP
Teknik Özellikler / Technical Specifications	
Malzeme / Material	4 mm Sac Metal (High Strength Rubber)
Ölçüler / Dimensions	50 x 50 x 5 cm
Renk / Color	Sarı / Yellow
Ağırlık / Weight	15 kg ± 0,5 kg



NVT 5701	
KAPAN KASIS KAPAĞI	IRON SNARE RAMP END
Teknik Özellikler / Technical Specifications	
Malzeme / Material	4 mm Sac Metal (High Strength Rubber)
Ölçüler / Dimensions	50 x 15 x 5 cm
Renk / Color	Sarı / Yellow
Ağırlık / Weight	5 kg ± 0,5 kg



NVT 5825	
KABLO KORUYUCU KASIS(İKİ KANALLI)	CABLE PROTECTOR ( TWO CHANNEL )
Teknik Özellikler / Technical Specifications	
Malzeme / Material	Kauçuk - PVC / Rubber - PVC
Genişlik / Widht	25 cm
Uzunluk / Length	100 cm
Yükseklik / Hight	4,5 cm
Renk / Color	Sarı - Siyah / Black - Yellow
Ağırlık / Weight	7,5 kg
Montaj / Assembly	Portatif / Portable

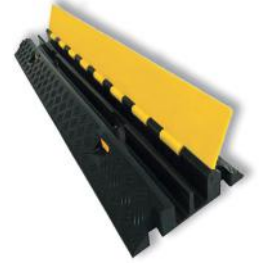

NVT 5855	
KABLO KORUYUCU KASIS(BEŞ KANALLI)	CABLE PROTECTOR (FIVE CHANNEL )
Teknik Özellikler / Technical Specifications	
Malzeme / Material	Kauçuk - PVC / Rubber - PVC
Genişlik / Widht	55 cm
Uzunluk / Length	90 cm
Yükseklik / Hight	5,5 cm
Renk / Color	Sarı - Siyah / Black - Yellow
Ağırlık / Weight	14,10 kg
Montaj / Assembly	Portatif / Portable

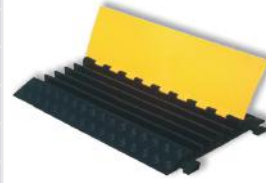

NVT 6000	
OVAL KOLON KORUYUCU	OVAL COLUMN PROTECTOR
Teknik Özellikler / Technical Specifications	
Malzeme / Material	Kauçuk / Rubber
Ölçüler / Dimensions	80 x 12 x 12 cm
Montaj / Assembly	8 mm Plastik Çivi, Silikon Yapıştırıcı 8 mm Plastic Nail, Silicone Adhesive
Ağırlık / Weight	2,6 kg
Reflektif / Reflective	Reflective Bantlar / Reflective Tapes



NVT 6001	
DÜZ KOLON KORUYUCU	COLUMN PROTECTOR
Teknik Özellikler / Technical Specifications	
Malzeme / Material	Kauçuk / Rubber
Ölçüler / Dimensions	80 x 10 x 0,8 cm
Montaj / Assembly	8 mm Plastik Çivi, Silikon Yapıştırıcı 8 mm Plastic Nail, Silicone Adhesive
Ağırlık / Weight	1,8 kg
Reflektif / Reflective	Reflective Bantlar / Reflective Tapes



NVT 6060	
KAUÇUK ARAÇ STOPERİ KISA	RUBBER WHEEL STOPPER 60 CM
Teknik Özellikler / Technical Specifications	
Malzeme / Material	Kauçuk / Rubber
Ölçüler / Dimensions	60 x 12 x 10 cm
Renk / Color	Siyah / Black
Özellik / Speciality	Gece Görüşüne Uygun Reflektörlü Suitable Reflective Night Vision
Montaj / Assembly	Ø10 x 110 mm Trifon Vida + Dübel Ø10 x 110 mm Trifon Screw + Dowel



NVT 6180	
KAUÇUK ARAÇ STOPERİ UZUN	RUBBER WHEEL STOPPER 180 CM
Teknik Özellikler / Technical Specifications	
Malzeme / Material	Kauçuk / Rubber
Ölçüler / Dimensions	183 x 15 x 10 cm
Renk / Color	Siyah / Black
Özellik / Speciality	Gece Görüşüne Uygun Reflektörlü Suitable Reflective Night Vision
Montaj / Assembly	Ø10 x 110 mm Trifon Vida + Dübel Ø10 x 110 mm Trifon Screw + Dowel



NVT 6160	
DEMİR ARAÇ STOPERİ 60 ÇAP	IRON WHEEL STOPPER Ø60
Teknik Özellikler / Technical Specifications	
Malzeme / Material	Ø60 x 2 mm Demir Boru (Ø60 x 2 mm Iron Pipe)
Ölçüler / Dimensions	183 x 15 x 10 cm
Renk / Color	Siyah Electrostatik, Fırın Boya Üzeri Sarı Reflektif Malzemeli Black Electrostatic Furnace Paint Over Yellow Reflective Material Should
Montaj / Assembly	10 x 120 mm Trifon Vida ve 16 m Plastik Dubel ile Montaj 10 x 120 mm with 16 mm Mounting Screws and Plastic Dowel Trifon



NVT 6176	
DEMİR ARAÇ STOPERİ 76 ÇAP	IRON WHEEL STOPPER Ø76
Teknik Özellikler / Technical Specifications	
Malzeme / Material	Ø76 x 2 mm Demir Boru (Ø76 x 2 mm Iron Pipe)
Ölçüler / Dimensions	180 x 12 cm
Renk / Color	Siyah Electrostatik, Fırın Boya Üzeri Sarı Reflektif Malzemeli Black Electrostatic Furnace Paint Over Yellow Reflective Material Should
Montaj / Assembly	10 x 120 mm Trifon Vida ve 16 m Plastik Dubel ile Montaj 10 x 120 mm with 16 mm Mounting Screws and Plastic Dowel Trifon



NVT 6200	
KİLİTLİ U DİREK	U SHAPE LOCKABLE BARRIER
Teknik Özellikler / Technical Specifications	
Malzeme / Material	Metal
Genişlik / Width	50 cm
Yükseklik / Height	40 cm



NVT 6246	
KİLİTLİ DİREK 4x6	4x6 LOCKABLE BARRIER
Teknik Özellikler / Technical Specifications	
Malzeme / Material	Metal
Genişlik / Width	4 x 6 cm
Yükseklik / Height	75 cm



NVT 6288	
KİLİTLİ DİREK 8x8	8x8 LOCKABLE BARRIER
Teknik Özellikler / Technical Specifications	
Malzeme / Material	Metal
Genişlik / Width	8 x 8 cm
Yükseklik / Height	75 cm



NVT 6300	
KOMPOZİT 47 CM DİREK	COMPOSITE POST 47 CM
Teknik Özellikler / Technical Specifications	
Malzeme / Material	Kompozit (Composite)
Ölçüler / Dimensions	48 x 25 cm
Renk / Color	10 kg
Montaj / Assembly	Vida ve Dübel ile Zemine Montaj Screw and Dowel Mounting on the Floor



NVT 6301	
CTP YOL KENAR DİKME	CTP POST
Teknik Özellikler / Technical Specifications	
Malzeme / Material	Fiberglass + Reflektif Fiberglass + Reflective
Genişlik / Width	10 cm
Kalınlık / Thickness	3 mm
Yükseklik / Height	130 cm
Renk / Color	Beyaz / White



NVT 6302		
KİLİTLİ ÇIKAR DİREK	IRON LOCKABLE POST	
Teknik Özellikler / Technical Specifications		
	1	2
Malzeme / Material	Metal	Metal
Boy / Height	75 cm	75 cm
Çap / Diameter	16 cm	16 cm
Kalınlık / Thickness	3 mm	3 mm
Boya / Dye	Statik	Statik
Kilit / Lock	Üçgen Anahtar (Triangle Lock)	Üçgen Anahtar (Triangle Lock)



NVT 6303	
SABİT DİREK	IRON FIXED POST
Teknik Özellikler / Technical Specifications	
Malzeme / Material	Metal
Boy / Height	75 cm
Çap / Diameter	16 cm
Kalınlık / Thickness	3 mm
Boya / Dye	Statik



NVT 6304	
OMEGA DİREK	OMEGA POST
Teknik Özellikler / Technical Specifications	
Malzeme / Material	Metal
Boy / Height	300 cm
Kalınlık / Thickness	3 mm
Delik Ölçüsü / Hole Measure	10 mm
Delik Aralığı / Hole Distance	20 mm



NVT 6445	
GÜVENLİK AYNASI 45 CM	CONVEX MIRROR 45 CM
Teknik Özellikler / Technical Specifications	
Malzeme / Material	Akrilik Lens, PP Çerçeve Acrylic Lens, PP Frame
Ölçüler / Dimensions	45 cm
Renk / Color	Turuncu / Orange
Özellik / Speciality	Akrilik Ayna / Acrylic Mirror
Montaj / Assembly	MØ8 Özel Aparatlı, Ø50 ile 75 Arası Direğe Montaj, Dubel ve Vidayla Duvara Montaj MØ8 Special Apparatus, Ø50 with 75 Inter Pole Mount, Dowel or Wall Mounting Screws.



NVT 6460	
GÜVENLİK AYNASI 60 CM	CONVEX MIRROR 60 CM
Teknik Özellikler / Technical Specifications	
Malzeme / Material	Akrilik Lens, PP Çerçeve Acrylic Lens, PP Frame
Ölçüler / Dimensions	60 cm
Renk / Color	Turuncu / Orange
Özellik / Speciality	Akrilik Ayna / Acrylic Mirror
Montaj / Assembly	MØ8 Özel Aparatlı, Ø50 ile 75 Arası Direğe Montaj, Dubel ve Vidayla Duvara Montaj MØ8 Special Apparatus, Ø50 with 75 Inter Pole Mount, Dowel or Wall Mounting Screws.



NVT 6480	
GÜVENLİK AYNASI 80 CM	CONVEX MIRROR 80 CM
Teknik Özellikler / Technical Specifications	
Malzeme / Material	Akrilik Lens, PP Çerçeve Acrylic Lens, PP Frame
Ölçüler / Dimensions	80 cm
Renk / Color	Turuncu / Orange
Özellik / Speciality	Akrilik Ayna / Acrylic Mirror
Montaj / Assembly	MØ8 Özel Aparatlı, Ø50 ile 75 Arası Direğe Montaj, Dubel ve Vidayla Duvara Montaj MØ8 Special Apparatus, Ø50 with 75 Inter Pole Mount, Dowel or Wall Mounting Screws.



NVT 6490	
GÜVENLİK AYNASI 90 CM	CONVEX MIRROR 90 CM
Teknik Özellikler / Technical Specifications	
Malzeme / Material	Akrilik Lens, PP Çerçeve Acrylic Lens, PP Frame
Ölçüler / Dimensions	90 cm
Renk / Color	Turuncu / Orange
Özellik / Speciality	Akrilik Ayna / Acrylic Mirror
Montaj / Assembly	MØ8 Özel Aparatlı, Ø50 ile 75 Arası Direğe Montaj, Dubel ve Vidayla Duvara Montaj MØ8 Special Apparatus, Ø50 with 75 Inter Pole Mount, Dowel or Wall Mounting Screws.



NVT 6500	
GÜVENLİK AYNASI 100 CM	CONVEX MIRROR 100 CM
Teknik Özellikler / Technical Specifications	
Malzeme / Material	Akrilik Lens, PP Çerçeve Acrylic Lens, PP Frame
Ölçüler / Dimensions	100 cm
Renk / Color	Turuncu / Orange
Özellik / Speciality	Akrilik Ayna / Acrylic Mirror
Montaj / Assembly	MØ8 Özel Aparatlı, Ø50 ile 75 Arası Direğe Montaj, Dubel ve Vidayla Duvara Montaj MØ8 Special Apparatus, Ø50 with 75 Inter Pole Mount, Dowel or Wall Mounting Screws.



NVT 6666	
6 MM PLASTİK ZİNCİR	6 MM PLASTIC CHAINS
Teknik Özellikler / Technical Specifications	
Malzeme / Material	PE
Ambalaj / Packing	100 mt'lik Kutuda. / 100 mt in the Box.
Renk / Color	Kırmızı, Beyaz / Red, White Renk Alternatifi Yüksek Metrajda İsteğinize Göre Yapılabilir. Color Can be Made According to Your Request Alternative High Quantities.



NVT 6668	
8 MM PLASTİK ZİNCİR	8 MM PLASTIC CHAINS
Teknik Özellikler / Technical Specifications	
Malzeme / Material	PE
Ambalaj / Packing	100 mt'lik Kutuda. / 100 mt in the Box.
Renk / Color	Kırmızı, Beyaz / Red, White Renk Alternatifi Yüksek Metrajda İsteğinize Göre Yapılabilir. Color Can be Made According to Your Request Alternative High Quantities.



## NVT 7001

AKORDİYON BARIYER  
KIRMIZI

ACCORDION BARRIER  
RED

Teknik Özellikler / Technical Specifications

Malzeme / Material	HDPE
Yükseklik / Height	110 cm
Kapalı Uzunluk / Close Length	13,6 cm
Açık Uzunluk / Open Length	230 cm
Taban Boyu / Base Length	48,5 cm
Boş Ağırlık / Empty Weight	6,8 kg
Dolu Ağırlık / Full Weight	17 kg
Renk / Color	Kırmızı + Reflektif / Red + Reflective

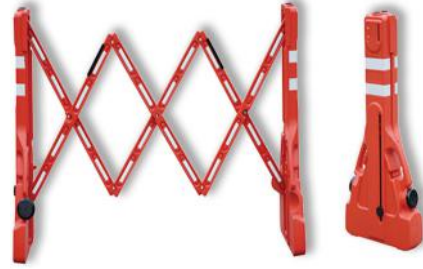

## NVT 7002

AKORDİYON BARIYER  
SARI

ACCORDION BARRIER  
YELLOW

Teknik Özellikler / Technical Specifications

Malzeme / Material	HDPE
Yükseklik / Height	94 cm
Kapalı Uzunluk / Close Length	23 cm
Açık Uzunluk / Open Length	250 cm
Taban Boyu / Base Length	38 cm
Boş Ağırlık / Empty Weight	2,2 kg
Dolu Ağırlık / Full Weight	9 kg
Renk / Color	Sarı + Reflektif / Yellow + Reflective



## NVT 7120

DİKME BARIYER  
KÜÇÜK

TRAFFIC BARRICADE  
( 30 x 90 )

Teknik Özellikler / Technical Specifications

Malzeme / Material	PPC - PVC
Ölçüler / Dimensions	180 x 120 cm
Ağırlık / Weight	27 kg
Özellik / Speciality	Reflektifli Baskı / Printed Reflective

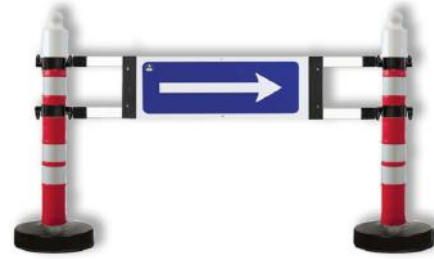

## NVT 7121

DİKME BARIYER  
KÜÇÜK

TRAFFIC BARRICADE  
( 75 x 125 )

Teknik Özellikler / Technical Specifications

Malzeme / Material	PPC - PVC
Ölçüler / Dimensions	180 x 120 cm
Ağırlık / Weight	27 kg
Özellik / Speciality	Reflektifli Baskı / Printed Reflective



## NVT 7200

PANEL BARIYER

PANEL BARRIER

Teknik Özellikler / Technical Specifications

Malzeme / Material	HDPE + Kauçuk (Rubber)
Ölçüler / Dimensions	100 x 200 x 3 cm
Renk / Color	Kırmızı / Red
Özellik / Speciality	360 Derece Dönebilen Kauçuk Ayaklar 360 Degree Rotatable Rubber Feet
Ağırlık / Weight	14 kg



## NVT 7201

PANEL BARIYER  
(BASKILI)

PANEL BARRIER  
(PRINTED)

Teknik Özellikler / Technical Specifications

Malzeme / Material	HDPE + Kauçuk (Rubber)
Ölçüler / Dimensions	100 x 200 x 3 cm
Renk / Color	Kırmızı / Red
Özellik / Speciality	360 Derece Dönebilen Kauçuk Ayaklar 360 Degree Rotatable Rubber Feet
Ağırlık / Weight	14 kg



NVT 7300	
ŞERİT KROM BARIYER	CHROME BARRIER
Teknik Özellikler / Technical Specifications	
Yükseklik / Height	91 cm
Çap / Diameter	6,3 cm
Taban Çapı / Base Color	32 cm
Ağırlık / Weight	4 kg
Renk / Color	Metalize



NVT 7200	
ZABITA BARIYERİ	IRON BARRIER
Teknik Özellikler / Technical Specifications	
Malzeme / Material	Demir / Iron
Yükseklik / Height	120 cm
Uzunluk / Length	180 cm
Ağırlık / Weight	9 kg
Renk / Color	Parlament Mavi / Parliament Blue



NVT 7500	
EMNİYET ALAN PERDESİ	SAFETY FENCE
Teknik Özellikler / Technical Specifications	
Malzeme / Material	PVC
Ölçüler / Dimensions	50 mt.
Renk / Color	Kırmızı / Red
Ağırlık / Weight	4 kg

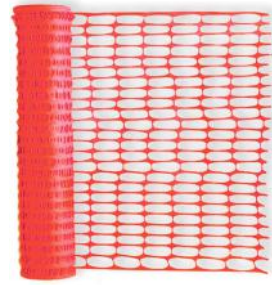

NVT 7700	
SU BARIYERİ	WATER BARRIER
Teknik Özellikler / Technical Specifications	
Malzeme / Material	LDHP
Ölçüler / Dimensions	50 x 50 x 120 cm
Renk / Color	Kırmızı- Beyaz / Red-White
Özellik / Speciality	10 kg
Ağırlık / Weight	100 lt



NVT 7701	
SU BARIYERİ	WATER BARRIER
Teknik Özellikler / Technical Specifications	
Malzeme / Material	LDHP
Ölçüler / Dimensions	50 x 50 x 120 cm
Renk / Color	Kırmızı- Beyaz / Red-White
Boş Ağırlık / Empty Weight	14 kg
Su Kapasitesi / Water Capacity	190 lt



NVT 7702	
SU BARIYERİ	WATER BARRIER
Teknik Özellikler / Technical Specifications	
Malzeme / Material	LDHP
Ölçüler / Dimensions	50 x 50 x 120 cm
Renk / Color	Kırmızı- Beyaz / Red-White
Boş Ağırlık / Empty Weight	18 kg
Su Kapasitesi / Water Capacity	250 lt

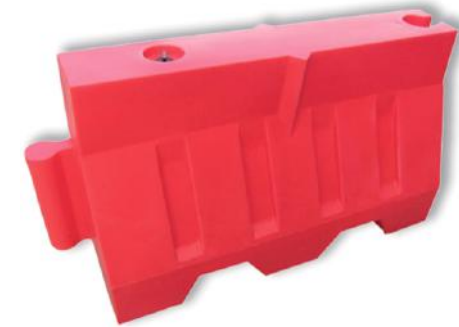

NVT 8020	
İKAZ ŞERİDİ	WARNING TAPES
Teknik Özellikler / Technical Specifications	
Malzeme / Material	PVC
Ölçüler / Dimensions	200 mt
Renk / Color	Kırmızı - Beyaz / Red - White
Genişlik / Width	7 cm



NVT 8050	
İKAZ ŞERİDİ	WARNING TAPES
Teknik Özellikler / Technical Specifications	
Malzeme / Material	PVC
Ölçüler / Dimensions	500 mt
Renk / Color	Kırmızı - Beyaz / Red - White
Genişlik / Width	7 cm



NVT 8120	
İKAZ ŞERİDİ	WARNING TAPES
Teknik Özellikler / Technical Specifications	
Malzeme / Material	PVC
Ölçüler / Dimensions	200 mt
Renk / Color	Sarı - Siyah / Yellow - Black
Genişlik / Width	7 cm



NVT 8150	
İKAZ ŞERİDİ	WARNING TAPES
Teknik Özellikler / Technical Specifications	
Malzeme / Material	PVC
Ölçüler / Dimensions	200 mt
Renk / Color	Sarı - Siyah / Yellow - Black
Genişlik / Width	7 cm



NVT 8200	
YER İŞARETLEME BANTLARI 5 CM	FLOOR MARKING TAPES ( 5 CM )
Teknik Özellikler / Technical Specifications	
Uzunluk / Length	30 mt
Genişlik / Width	5 cm
Renk / Color	8250/A Sarı / Yellow 8250/B Lacivert / Dark Blue 8250/C Kırmızı / Red 8250/D Beyaz / White 8250/E Yeşil / Green 8250/F Kırmızı-Beyaz / Red-White 8250/G Sarı-Siyah / Yellow-Black



NVT 8250	
YER İŞARETLEME BANTLARI 10 CM	FLOOR MARKING TAPES ( 10 CM )
Teknik Özellikler / Technical Specifications	
Uzunluk / Length	30 mt
Genişlik / Width	10 cm
Renk / Color	8250/A Sarı / Yellow 8250/B Lacivert / Dark Blue 8250/C Kırmızı / Red 8250/D Beyaz / White 8250/E Yeşil / Green 8250/F Kırmızı-Beyaz / Red-White 8250/G Sarı-Siyah / Yellow-Black



NVT 8302	
KAYDIRMAZ BANTLAR	ANTI SLIP TAPES
Teknik Özellikler / Technical Specifications	
Uzunluk / Length	15 mt
Genişlik / Width	2,5 cm



NVT 8305	
KAYDIRMAZ BANTLAR	ANTI SLIP TAPES
Teknik Özellikler / Technical Specifications	
Uzunluk / Length	15 mt
Genişlik / Width	2,5 cm



NVT 8312	
KAYDIRMAZ BANTLAR	ANTI SLIP TAPES
Teknik Özellikler / Technical Specifications	
Uzunluk / Length	25 mt
Genişlik / Width	2,5 cm



NVT 8315	
KAYDIRMAZ BANTLAR	ANTI SLIP TAPES
Teknik Özellikler / Technical Specifications	
Uzunluk / Length	25 mt
Genişlik / Width	5 cm



NVT 8401	
REFLEKTİF BANT	REFLECTIVE TAPES
Teknik Özellikler / Technical Specifications	
Uzunluk / Length	46 mt
Genişlik / Width	5 cm
Renk / Color	Kırmızı-Beyaz Red-White



NVT 8402	
REFLEKTİF BANT	REFLECTIVE TAPES
Teknik Özellikler / Technical Specifications	
Uzunluk / Length	46 mt
Genişlik / Width	5 cm
Renk / Color	Sarı-Siyah Yellow-Black





NVT 8403	
REFLEKTİF BANT	REFLECTIVE TAPES
Teknik Özellikler / <i>Technical Specifications</i>	
Uzunluk / <i>Lenght</i>	46 mt
Genişlik / <i>Width</i>	10 cm
Renk / <i>Color</i>	Kırmızı-Beyaz <i>Red-White</i>

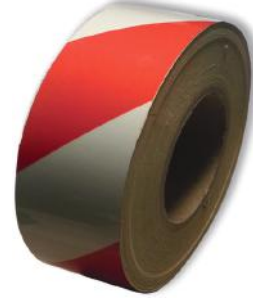

NVT 8404	
REFLEKTİF BANT	REFLECTIVE TAPES
Teknik Özellikler / <i>Technical Specifications</i>	
Uzunluk / <i>Lenght</i>	46 mt
Genişlik / <i>Width</i>	10cm
Renk / <i>Color</i>	Sarı-Siyah <i>Yellow-Black</i>

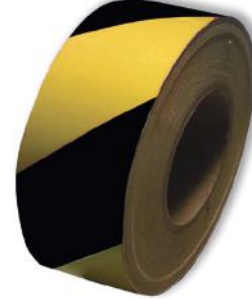

NVT 8405	
REFLEKTİF BANT	REFLECTIVE TAPES
Teknik Özellikler / <i>Technical Specifications</i>	
Uzunluk / <i>Lenght</i>	46 mt
Genişlik / <i>Width</i>	5 cm
Renk / <i>Color</i>	Beyaz Petekli Yüksek Performans <i>White Honey Comp High Performance</i>



NVT 8406	
REFLEKTİF BANT	REFLECTIVE TAPES
Teknik Özellikler / <i>Technical Specifications</i>	
Uzunluk / <i>Lenght</i>	46 mt
Genişlik / <i>Width</i>	5 cm
Renk / <i>Color</i>	Sarı Petekli Yüksek Performans <i>Yellow Honey Comp High Performance</i>



NVT 8407	
REFLEKTİF BANT	REFLECTIVE TAPES
Teknik Özellikler / <i>Technical Specifications</i>	
Uzunluk / <i>Lenght</i>	46 mt
Genişlik / <i>Width</i>	5 cm
Renk / <i>Color</i>	Kırmızı Petekli Yüksek Performans <i>Red Honey Comp High Performance</i>



NVT 8408	
REFLEKTİF BANT	REFLECTIVE TAPES
Teknik Özellikler / <i>Technical Specifications</i>	
Uzunluk / <i>Lenght</i>	46 mt
Genişlik / <i>Width</i>	5 cm
Renk / <i>Color</i>	Metalize Petekli Yüksek Performans <i>Metalized Honey Comp High Performance</i>



NVT 8409	
REFLEKTİF BANT	REFLECTIVE TAPES
Teknik Özellikler / <i>Technical Specifications</i>	
Uzunluk / <i>Lenght</i>	46 mt
Genişlik / <i>Width</i>	10 cm
Renk / <i>Color</i>	Beyaz Petekli Yüksek Performans <i>White Honey Comp High Performance</i>



NVT 8410	
REFLEKTİF BANT	REFLECTIVE TAPES
Teknik Özellikler / <i>Technical Specifications</i>	
Uzunluk / <i>Lenght</i>	46 mt
Genişlik / <i>Width</i>	10 cm
Renk / <i>Color</i>	Sarı Petekli Yüksek Performans <i>Yellow Honey Comp High Performance</i>



NVT 8411	
REFLEKTİF BANT	REFLECTIVE TAPES
Teknik Özellikler / <i>Technical Specifications</i>	
Uzunluk / <i>Lenght</i>	46 mt
Genişlik / <i>Width</i>	10 cm
Renk / <i>Color</i>	Kırmızı Petekli Yüksek Performans <i>Red Honey Comp High Performance</i>



NVT 8412	
REFLEKTİF BANT	REFLECTIVE TAPES
Teknik Özellikler / <i>Technical Specifications</i>	
Uzunluk / <i>Lenght</i>	46 mt
Genişlik / <i>Width</i>	10 cm
Renk / <i>Color</i>	Metalize Petekli Yüksek Performans <i>Metalized Honey Comp High Performance</i>



NVT 9000	
UYARI TABELASI	WARNING BOARD
Teknik Özellikler / <i>Technical Specifications</i>	
Malzeme / <i>Material</i>	PP
Ölçüler / <i>Dimensions</i>	16 x 75 cm
Renk / <i>Color</i>	Beyaz / <i>White</i>
Ağırlık / <i>Weight</i>	600 gr ± 20 gr



NVT 9100	
YUVARLAK TABELA	ROUND BOARD
Teknik Özellikler / <i>Technical Specifications</i>	
Malzeme / <i>Material</i>	PP
Ölçüler / <i>Dimensions</i>	28 x 39 cm
Renk / <i>Color</i>	Beyaz / <i>White</i>
Ağırlık / <i>Weight</i>	240 gr ± 20 gr



NVT 9200	
ÜÇGEN TABELA	TRIANGLE BOARD
Teknik Özellikler / Technical Specifications	
Malzeme / Material	PP
Ölçüler / Dimensions	35 x 43 cm
Renk / Color	Beyaz / White
Ağırlık / Weight	400 gr ± 20 gr



NVT 9300	
DİKDÖRTGEN TABELA	RECTANGLE BOARD
Teknik Özellikler / Technical Specifications	
Malzeme / Material	PP
Ölçüler / Dimensions	35 x 41 cm
Renk / Color	Beyaz / White
Ağırlık / Weight	700 gr ± 40 gr



NVT 9400	
DUR GEÇ EL TİPİ	GO AND STOP SIGN FOR HAND
Teknik Özellikler / Technical Specifications	
Malzeme / Material	PP
Çap / Diameter	20 cm



NVT 9101	
AZAMİ HIZ TABELASI (TEK TARAFLI)	30 KM MAXIMUM VELOCITY BOARD (ONE SIDED)
Teknik Özellikler / Technical Specifications	
Malzeme / Material	PP
Ölçüler / Dimensions	28 x 39 cm
Renk / Color	Beyaz / White
Ağırlık / Weight	240 gr ± 20 gr



NVT 9102	
AZAMİ HIZ TABELASI (TEK TARAFLI)	50 KM MAXIMUM VELOCITY BOARD (ONE SIDED)
Teknik Özellikler / Technical Specifications	
Malzeme / Material	PP
Ölçüler / Dimensions	28 x 39 cm
Renk / Color	Beyaz / White
Ağırlık / Weight	240 gr ± 20 gr



NVT 9103	
AZAMİ HIZ TABELASI (TEK TARAFLI)	60 KM MAXIMUM VELOCITY BOARD (ONE SIDED)
Teknik Özellikler / Technical Specifications	
Malzeme / Material	PP
Ölçüler / Dimensions	28 x 39 cm
Renk / Color	Beyaz / White
Ağırlık / Weight	240 gr ± 20 gr



NVT 9104	
PARK YAPILAMAZ TABELASI (ÇİFT TARAFLI)	NO PARKING BOARD (TWO SIDED)
Teknik Özellikler / Technical Specifications	
Malzeme / Material	PP
Ölçüler / Dimensions	28 x 39 cm
Renk / Color	Beyaz / White
Ağırlık / Weight	240 gr ± 20 gr



NVT 9105	
GİRİŞİ OLMAYAN YOL (TEK TARAFLI)	NO ENTRY BOARD (ONE SIDED)
Teknik Özellikler / Technical Specifications	
Malzeme / Material	PP
Ölçüler / Dimensions	28 x 39 cm
Renk / Color	Beyaz / White
Ağırlık / Weight	240 gr ± 20 gr



NVT 9106	
SAĞA MECBURİ YÖN TABELASI (ÇİFT TARAFLI)	RIGHT ONLY BOARD (TWO SIDED)
Teknik Özellikler / Technical Specifications	
Malzeme / Material	PP
Ölçüler / Dimensions	28 x 39 cm
Renk / Color	Beyaz / White
Ağırlık / Weight	240 gr ± 20 gr



NVT 9107	
SOLA MECBURİ YÖN TABELASI (ÇİFT TARAFLI)	LEFT ONLY BOARD (TWO SIDED)
Teknik Özellikler / Technical Specifications	
Malzeme / Material	PP
Ölçüler / Dimensions	28 x 39 cm
Renk / Color	Beyaz / White
Ağırlık / Weight	240 gr ± 20 gr



NVT 9108	
SAĞDAN GİDİNİZ TABELASI (TEK TARAFLI)	KEEP RIGHT BOARD (ONE SIDED)
Teknik Özellikler / Technical Specifications	
Malzeme / Material	PP
Ölçüler / Dimensions	28 x 39 cm
Renk / Color	Beyaz / White
Ağırlık / Weight	240 gr ± 20 gr



NVT 9109	
SOLDAN GİDİNİZ TABELASI (TEK TARAFLI)	KEEP LEFT BOARD (ONE SIDED)
Teknik Özellikler / Technical Specifications	
Malzeme / Material	PP
Ölçüler / Dimensions	28 x 39 cm
Renk / Color	Beyaz / White
Ağırlık / Weight	240 gr ± 20 gr



NVT 9110	
DUR TABELASI (TEK TARAFLI)	STOP BOARD (ONE SIDED)
Teknik Özellikler / Technical Specifications	
Malzeme / Material	PP
Ölçüler / Dimensions	28 x 39 cm
Renk / Color	Beyaz / White
Ağırlık / Weight	240 gr ± 20 gr



NVT 9111	
AZAMI HIZ TABELASI (TEK TARAFLI)	10 KM MAXIMUM VELOCITY BOARD (ONE SIDED)
Teknik Özellikler / Technical Specifications	
Malzeme / Material	PP
Ölçüler / Dimensions	28 x 39 cm
Renk / Color	Beyaz / White
Ağırlık / Weight	240 gr ± 20 gr



NVT 9112	
AZAMI HIZ TABELASI (TEK TARAFLI)	20 KM MAXIMUM VELOCITY BOARD (ONE SIDED)
Teknik Özellikler / Technical Specifications	
Malzeme / Material	PP
Ölçüler / Dimensions	28 x 39 cm
Renk / Color	Beyaz / White
Ağırlık / Weight	240 gr ± 20 gr



NVT 9201	
DUR TABELASI (TEK TARAFLI)	STOP BOARD (ONE SIDED)
Teknik Özellikler / Technical Specifications	
Malzeme / Material	PP
Ölçüler / Dimensions	35 x 43 cm
Renk / Color	Beyaz / White
Ağırlık / Weight	380 gr ± 20 gr



NVT 9202	
DUR TABELASI (TEK TARAFLI)	ATTENTION BOARD (TWO SIDED)
Teknik Özellikler / Technical Specifications	
Malzeme / Material	PP
Ölçüler / Dimensions	35 x 43 cm
Renk / Color	Beyaz / White
Ağırlık / Weight	380 gr ± 20 gr



NVT 9203	
DİKKAT İKİ YÖNLÜ TRAFİK TABELASI (ÇİFT TARAFLI)	ATTENTION TWO WAY TRAFFIC BOARD (TWO SIDED)
Teknik Özellikler / Technical Specifications	
Malzeme / Material	PP
Ölçüler / Dimensions	35 x 43 cm
Renk / Color	Beyaz / White
Ağırlık / Weight	380 gr ± 20 gr



NVT 9204	
SOLDAN DARALAN YOL TABELASI (TEK TARAFLI)	NARROWING ROAD FROM LEFT BOARD (ONE SIDED)
Teknik Özellikler / Technical Specifications	
Malzeme / Material	PP
Ölçüler / Dimensions	35 x 43 cm
Renk / Color	Beyaz / White
Ağırlık / Weight	380 gr ± 20 gr



NVT 9205	
SAĞDAN DARALAN YOL TABELASI (TEK TARAFLI)	NARROWING ROAD FROM RIGHT BOARD (ONE SIDED)
Teknik Özellikler / Technical Specifications	
Malzeme / Material	PP
Ölçüler / Dimensions	35 x 43 cm
Renk / Color	Beyaz / White
Ağırlık / Weight	380 gr ± 20 gr



NVT 9206	
HER İKİ TARAFTAN DARALAN YOL TABELASI (TEK TARAFLI)	NARROWING ROAD SIDES BOARD (ONE SIDED)
Teknik Özellikler / Technical Specifications	
Malzeme / Material	PP
Ölçüler / Dimensions	35 x 43 cm
Renk / Color	Beyaz / White
Ağırlık / Weight	380 gr ± 20 gr



NVT 9207	
KASİSLİ YOL TABELASI (TEK TARAFLI)	BUMPY ROAD BOARD (ONE SIDED)
Teknik Özellikler / Technical Specifications	
Malzeme / Material	PP
Ölçüler / Dimensions	35 x 43 cm
Renk / Color	Beyaz / White
Ağırlık / Weight	380 gr ± 20 gr



NVT 9208	
YAYA GEÇİDİ TABELASI (TEK TARAFLI)	CROSSWALK BOARD (ONE SIDED)
Teknik Özellikler / Technical Specifications	
Malzeme / Material	PP
Ölçüler / Dimensions	35 x 43 cm
Renk / Color	Beyaz / White
Ağırlık / Weight	380 gr ± 20 gr



NVT 9301	
SOLDAN GİDİNİZ TABELASI (TEK TARAFLI)	KEEP LEFT BOARD (ONE SIDED)
Teknik Özellikler / Technical Specifications	
Malzeme / Material	PP
Ölçüler / Dimensions	35 x 41 cm
Renk / Color	Beyaz / White
Ağırlık / Weight	700 gr ± 40 gr



NVT 9302	
ENGELLİ PARK YERİ (ÇİFT TARAFLI)	KEEP RIGHT BOARD ( ONE SIDED )
Teknik Özellikler / Technical Specifications	
Malzeme / Material	PP
Ölçüler / Dimensions	35 x 41 cm
Renk / Color	Beyaz / White
Ağırlık / Weight	700 gr ± 40 gr



NVT 9303	
DİKKAT İKİ YÖNLÜ TRAFİK TABELASI (ÇİFT TARAFLI)	WARNING TWO WAY TRAFFIC BOARD ( TWO SIDED )
Teknik Özellikler / Technical Specifications	
Malzeme / Material	PP
Ölçüler / Dimensions	35 x 41 cm
Renk / Color	Beyaz / White
Ağırlık / Weight	700 gr ± 40 gr



NVT 9304	
DİKKAT UYARI TABELASI (ÇİFT TARAFLI)	ATTENTION BOARD ( TWO SIDED )
Teknik Özellikler / Technical Specifications	
Malzeme / Material	PP
Ölçüler / Dimensions	35 x 41 cm
Renk / Color	Beyaz / White
Ağırlık / Weight	700 gr ± 40 gr



NVT 9305	
DİKKAT ÇALIŞMA VAR TABELASI (ÇİFT TARAFLI)	ATTENTION ROADWORK BOARD ( TWO SIDED )
Teknik Özellikler / Technical Specifications	
Malzeme / Material	PP
Ölçüler / Dimensions	35 x 41 cm
Renk / Color	Beyaz / White
Ağırlık / Weight	700 gr ± 40 gr



NVT 9306	
AZAMİ HIZ TABELASI (TEK TARAFLI)	30 KM MAXIMUM VELOCITY BOARD ( ONE SIDED )
Teknik Özellikler / Technical Specifications	
Malzeme / Material	PP
Ölçüler / Dimensions	35 x 41 cm
Renk / Color	Beyaz / White
Ağırlık / Weight	700 gr ± 40 gr



NVT 9307	
ENGELLİ PARK YERİ (ÇİFT TARAFLI)	KEEP RIGHT BOARD ( ONE SIDED )
Teknik Özellikler / Technical Specifications	
Malzeme / Material	PP
Ölçüler / Dimensions	35 x 41 cm
Renk / Color	Beyaz / White
Ağırlık / Weight	700 gr ± 40 gr



NVT 9308	
AZAMİ HIZ TABELASI (TEK TARAFLI)	60 KM MAXIMUM VELOCITY BOARD ( ONE SIDED )
Teknik Özellikler / Technical Specifications	
Malzeme / Material	PP
Ölçüler / Dimensions	35 x 41 cm
Renk / Color	Beyaz / White
Ağırlık / Weight	700 gr ± 40 gr



NVT 9309	
DİKKAT ÇALIŞMA VAR TABELASI (ÇİFT TARAFLI)	SLOW WARNING BOARD ( ONE SIDED )
Teknik Özellikler / Technical Specifications	
Malzeme / Material	PP
Ölçüler / Dimensions	35 x 41 cm
Renk / Color	Beyaz / White
Ağırlık / Weight	700 gr ± 40 gr



NVT 9310	
SAĞDAN GİDİNİZ TABELASI (TEK TARAFLI)	KEEP RIGHT BOARD ( ONE SIDED )
Teknik Özellikler / Technical Specifications	
Malzeme / Material	PP
Ölçüler / Dimensions	35 x 41 cm
Renk / Color	Beyaz / White
Ağırlık / Weight	700 gr ± 40 gr



not GELECEK

NVT 9500	
SOLAR FLAŞÖR SARI	YELLOW SOLAR FLASHER
Teknik Özellikler / Technical Specifications	
Malzeme / Material	Gövde ABS, Cam Polikarbonat (Body ABS, Polycarbonate Glass)
Ölçüler / Dimensions	9 x 23,5 x 29 cm
Renk / Color	Sarı / Yellow
Ağırlık / Weight	0,800 kg
Özellik / Speciality	Çift yönlü, 4+4 Led, 2x1 Power Led (Two-way, 4+4 Led, 2x1 Power Led)



NVT 9501	
SOLAR FLAŞÖR KIRMIZI	RED SOLAR FLASHER
Teknik Özellikler / Technical Specifications	
Malzeme / Material	Gövde ABS, Cam Polikarbonat (Body ABS, Polycarbonate Glass)
Ölçüler / Dimensions	9 x 23,5 x 29 cm
Renk / Color	Kırmızı / Red
Ağırlık / Weight	0,800 kg
Özellik / Speciality	Çift yönlü, 4+4 Led, 2x1 Power Led (Two-way, 4+4 Led, 2x1 Power Led)



NVT 9520	
200' LÜK FLAŞÖR SARI	Ø200 SOLAR LED FLASHER YELLOW
Teknik Özellikler / Technical Specifications	
Malzeme / Material	Gövde Polikarbon / Polycarbonate Frame
Ölçüler / Dimensions	24 x 24 cm
Led / Color	5 mm Şeffaf, Sarı, Kırmızı / 5 mm Colorless, Yellow Red
Solar Akü / SolarBattery	10W Polikristal Solar/ 12V7Ah Kuru Tip Akü (10W Polycrystal Solar/ 12V7Ah Dry-Type Battery)
Özellik / Speciality	7 kg



NVT 9521	
200' LÜK FLAŞÖR KIRMIZI	Ø200 SOLAR LED FLASHER RED
Teknik Özellikler / Technical Specifications	
Malzeme / Material	Gövde Polikarbon / Polycarbonate Frame
Ölçüler / Dimensions	24 x 24 cm
Led /	5 mm Şeffaf, Sarı, Kırmızı / 5 mm Colorless, Yellow Red
Solar Akü / SolarBattery	10W Polikristal Solar/ 12V7Ah Kuru Tip Akü (10W Polycrystal Solar/ 12V7Ah Dry-Type Battery)
Ağırlık / Weight	7 kg



NVT 9530	
300' LÜK FLAŞÖR SARI	Ø300 SOLAR LED FLASHER YELLOW
Teknik Özellikler / Technical Specifications	
Malzeme / Material	Gövde Polikarbon / Polycarbonate Frame
Ölçüler / Dimensions	36 x 36 cm
Led / Color	5 mm Şeffaf, Sarı, Kırmızı / 5 mm Colorless, Yellow Red
Solar Akü / SolarBattery	10W Polikristal Solar/ 12V7Ah Kuru Tip Akü (10W Polycrystal Solar/ 12V7Ah Dry-Type Battery)
Özellik / Speciality	9 kg



NVT 9531	
300' LÜK FLAŞÖR KIRMIZI	Ø300 SOLAR LED FLASHER RED
Teknik Özellikler / Technical Specifications	
Malzeme / Material	Gövde Polikarbon / Polycarbonate Frame
Ölçüler / Dimensions	36 x 36 cm
Led / Color	5 mm Şeffaf, Sarı, Kırmızı / 5 mm Colorless, Yellow Red
Solar Akü / SolarBattery	10W Polikristal Solar/ 12V7Ah Kuru Tip Akü (10W Polycrystal Solar/ 12V7Ah Dry-Type Battery)
Özellik / Speciality	9 kg



NVT 9522	
200' LÜK FLAŞÖR ÇİFTLİ	Ø200 SOLAR LED FLASHER RED AND YELLOW
Teknik Özellikler / Technical Specifications	
Malzeme / Material	Gövde Polikarbon / Polycarbonate Frame
Ölçüler / Dimensions	24 x 24 x2 cm
Led /	5 mm Şeffaf, Sarı, Kırmızı / 5 mm Colorless, Yellow Red
Solar Akü / SolarBattery	10W Polikristal Solar/ 12V7Ah Kuru Tip Akü (10W Polycrystal Solar/ 12V7Ah Dry-Type Battery)
Ağırlık / Weight	14 kg



NVT 9533	
300' LÜK FLAŞÖR ÇİFTLİ	Ø300 SOLAR LED FLASHER RED AND YELLOW
Teknik Özellikler / Technical Specifications	
Malzeme / Material	Gövde Polikarbon / Polycarbonate Frame
Ölçüler / Dimensions	36 x 36 x2 cm
Led / Color	5 mm Şeffaf, Sarı, Kırmızı / 5 mm Colorless, Yellow Red
Solar Akü / SolarBattery	10W Polikristal Solar/ 12V7Ah Kuru Tip Akü (10W Polycrystal Solar/ 12V7Ah Dry-Type Battery)
Özellik / Speciality	14 kg



NVT 9601	SAĞA DEVAMLİ VİRAJ 60 x 60 cm	DOUBLE BEND TO RIGHT 60 x 60 cm
Teknik Özellikler		Technical Specifications
Malzeme / Material	1 mm Statik Toz Boyalı Saç Kasa	1 mm Static Dyed Metal Frame
Ölçüler / Dimensions	60 x 60 x 4 cm	60 x 60 x 4 cm
Led	5 mm Şeffaf/Kırmızı/Beyaz. 8 mm Led Lensi	5 mm Colorless/Red/White. 8 mm Led
Solar Akü / Solar Battery	10W Polikristal Solar/ 12V7Ah Kuru Tip Akü	10W Polycrystal Solar/ 12VAh Dry-Type Battery
Reflektif / Reflective	Reflektif Folyo Üzeri Transparan Kaplama	Reflective Transparent Covered
Ağırlık / Weight	18 kg	18 kg



NVT 9602	SOLA DEVAMLİ VİRAJ 60 x 60 cm	DOUBLE BEND TO LEFT 60 x 60 cm
Teknik Özellikler		Technical Specifications
Malzeme / Material	1 mm Statik Toz Boyalı Saç Kasa	1 mm Static Dyed Metal Frame
Ölçüler / Dimensions	60 x 60 x 4 cm	60 x 60 x 4 cm
Led	5 mm Şeffaf/Kırmızı/Beyaz. 8 mm Led Lensi	5 mm Colorless/Red/White. 8 mm Led
Solar Akü / Solar Battery	10W Polikristal Solar/ 12V7Ah Kuru Tip Akü	10W Polycrystal Solar/ 12VAh Dry-Type Battery
Reflektif / Reflective	Reflektif Folyo Üzeri Transparan Kaplama	Reflective Transparent Covered
Ağırlık / Weight	18 kg	18 kg



NVT 9603	GİRİLMEZ LEVHASI 60 x 60 cm	NO ENTRY 60 x 60 cm
Teknik Özellikler		Technical Specifications
Malzeme / Material	1 mm Statik Toz Boyalı Saç Kasa	1 mm Static Dyed Metal Frame
Ölçüler / Dimensions	60 x 60 x 4 cm	60 x 60 x 4 cm
Led	5 mm Şeffaf/Kırmızı/Beyaz. 8 mm Led Lensi	5 mm Colorless/Red/White. 8 mm Led
Solar Akü / Solar Battery	10W Polikristal Solar/ 12V7Ah Kuru Tip Akü	10W Polycrystal Solar/ 12VAh Dry-Type Battery
Reflektif / Reflective	Reflektif Folyo Üzeri Transparan Kaplama	Reflective Transparent Covered
Ağırlık / Weight	18 kg	18 kg



NVT 9604	YAYA GEÇİDİ 60 x 60 cm	PEDESTRIAN CROSSING 60 x 60 cm
Teknik Özellikler		Technical Specifications
Malzeme / Material	1 mm Statik Toz Boyalı Saç Kasa	1 mm Static Dyed Metal Frame
Ölçüler / Dimensions	60 x 60 x 4 cm	60 x 60 x 4 cm
Led	5 mm Şeffaf/Kırmızı/Beyaz. 8 mm Led Lensi	5 mm Colorless/Red/White. 8 mm Led
Solar Akü / Solar Battery	10W Polikristal Solar/ 12V7Ah Kuru Tip Akü	10W Polycrystal Solar/ 12VAh Dry-Type Battery
Reflektif / Reflective	Reflektif Folyo Üzeri Transparan Kaplama	Reflective Transparent Covered
Ağırlık / Weight	18 kg	18 kg



NVT 9605	KASIS 60 x 60 cm	BUMPY ROAD 60 x 60 cm
Teknik Özellikler		Technical Specifications
Malzeme / Material	1 mm Statik Toz Boyalı Saç Kasa	1 mm Static Dyed Metal Frame
Ölçüler / Dimensions	60 x 60 x 4 cm	60 x 60 x 4 cm
Led	5 mm Şeffaf/Kırmızı/Beyaz. 8 mm Led Lensi	5 mm Colorless/Red/White. 8 mm Led
Solar Akü / Solar Battery	10W Polikristal Solar/ 12V7Ah Kuru Tip Akü	10W Polycrystal Solar/ 12VAh Dry-Type Battery
Reflektif / Reflective	Reflektif Folyo Üzeri Transparan Kaplama	Reflective Transparent Covered
Ağırlık / Weight	18 kg	18 kg



NVT 9606	MAVİ YAYA GEÇİDİ 60 x 60 cm	PEDESTRIAN CROSSING 60 x 60 cm
Teknik Özellikler		Technical Specifications
Malzeme / Material	1 mm Statik Toz Boyalı Saç Kasa	1 mm Static Dyed Metal Frame
Ölçüler / Dimensions	60 x 60 x 4 cm	60 x 60 x 4 cm
Led	5 mm Şeffaf/Kırmızı/Beyaz. 8 mm Led Lensi	5 mm Colorless/Red/White. 8 mm Led
Solar Akü / Solar Battery	10W Polikristal Solar/ 12V7Ah Kuru Tip Akü	10W Polycrystal Solar/ 12VAh Dry-Type Battery
Reflektif / Reflective	Reflektif Folyo Üzeri Transparan Kaplama	Reflective Transparent Covered
Ağırlık / Weight	18 kg	18 kg



NVT 9607		HER İKİ YÖNE LEVHASI 60 x 60 cm	ONLY TWO WAY 60 x 60 cm
Teknik Özellikler		Technical Specifications	
Malzeme / Material	1 mm Statik Toz Boyalı Saç Kasa	1 mm Static Dyed Metal Frame	
Ölçüler / Dimensions	60 x 60 x 4 cm	60 x 60 x 4 cm	
Led	5 mm Şeffaf/Kırmızı/Beyaz. 8 mm Led Lensi	5 mm Colorless/Red/White. 8 mm Led	
Solar Akü / Solar Battery	10W Polikristal Solar/ 12V7Ah Kuru Tip Akü	10W Polycrystal Solar/ 12VAh Dry-Type Battery	
Reflektif / Reflective	Reflektif Folyo Üzeri Transparan Kaplama	Reflective Transparent Covered	
Ağırlık / Weight	18 kg	18 kg	



NVT 9608		SOLA MECBURİ YÖN 60 x 60 cm	KEEP LEFT 60 x 60 cm
Teknik Özellikler		Technical Specifications	
Malzeme / Material	1 mm Statik Toz Boyalı Saç Kasa	1 mm Static Dyed Metal Frame	
Ölçüler / Dimensions	60 x 60 x 4 cm	60 x 60 x 4 cm	
Led	5 mm Şeffaf/Kırmızı/Beyaz. 8 mm Led Lensi	5 mm Colorless/Red/White. 8 mm Led	
Solar Akü / Solar Battery	10W Polikristal Solar/ 12V7Ah Kuru Tip Akü	10W Polycrystal Solar/ 12VAh Dry-Type Battery	
Reflektif / Reflective	Reflektif Folyo Üzeri Transparan Kaplama	Reflective Transparent Covered	
Ağırlık / Weight	18 kg	18 kg	



NVT 9609		SAĞA MECBURİ YÖN 60 x 60 cm	KEEP RIGHT 60 x 60 cm
Teknik Özellikler		Technical Specifications	
Malzeme / Material	1 mm Statik Toz Boyalı Saç Kasa	1 mm Static Dyed Metal Frame	
Ölçüler / Dimensions	60 x 60 x 4 cm	60 x 60 x 4 cm	
Led	5 mm Şeffaf/Kırmızı/Beyaz. 8 mm Led Lensi	5 mm Colorless/Red/White. 8 mm Led	
Solar Akü / Solar Battery	10W Polikristal Solar/ 12V7Ah Kuru Tip Akü	10W Polycrystal Solar/ 12VAh Dry-Type Battery	
Reflektif / Reflective	Reflektif Folyo Üzeri Transparan Kaplama	Reflective Transparent Covered	
Ağırlık / Weight	18 kg	18 kg	



NVT 9610		SOLDAN GİDİNİZ 60 x 60 cm	LEFT ONLY 60 x 60 cm
Teknik Özellikler		Technical Specifications	
Malzeme / Material	1 mm Statik Toz Boyalı Saç Kasa	1 mm Static Dyed Metal Frame	
Ölçüler / Dimensions	60 x 60 x 4 cm	60 x 60 x 4 cm	
Led	5 mm Şeffaf/Kırmızı/Beyaz. 8 mm Led Lensi	5 mm Colorless/Red/White. 8 mm Led	
Solar Akü / Solar Battery	10W Polikristal Solar/ 12V7Ah Kuru Tip Akü	10W Polycrystal Solar/ 12VAh Dry-Type Battery	
Reflektif / Reflective	Reflektif Folyo Üzeri Transparan Kaplama	Reflective Transparent Covered	
Ağırlık / Weight	18 kg	18 kg	

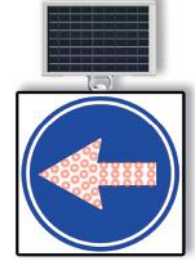

NVT 9611		SAĞDAN GİDİNİZ 60 x 60 cm	RIGHT ONLY 60 x 60 cm
Teknik Özellikler		Technical Specifications	
Malzeme / Material	1 mm Statik Toz Boyalı Saç Kasa	1 mm Static Dyed Metal Frame	
Ölçüler / Dimensions	60 x 60 x 4 cm	60 x 60 x 4 cm	
Led	5 mm Şeffaf/Kırmızı/Beyaz. 8 mm Led Lensi	5 mm Colorless/Red/White. 8 mm Led	
Solar Akü / Solar Battery	10W Polikristal Solar/ 12V7Ah Kuru Tip Akü	10W Polycrystal Solar/ 12VAh Dry-Type Battery	
Reflektif / Reflective	Reflektif Folyo Üzeri Transparan Kaplama	Reflective Transparent Covered	
Ağırlık / Weight	18 kg	18 kg	

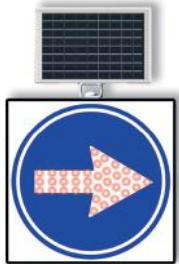

NVT 9612		İLERİ VE SOLA MECBURİ YÖN 60 x 60 cm	ONLY AHEAD AND LEFT 60 x 60 cm
Teknik Özellikler		Technical Specifications	
Malzeme / Material	1 mm Statik Toz Boyalı Saç Kasa	1 mm Static Dyed Metal Frame	
Ölçüler / Dimensions	60 x 60 x 4 cm	60 x 60 x 4 cm	
Led	5 mm Şeffaf/Kırmızı/Beyaz. 8 mm Led Lensi	5 mm Colorless/Red/White. 8 mm Led	
Solar Akü / Solar Battery	10W Polikristal Solar/ 12V7Ah Kuru Tip Akü	10W Polycrystal Solar/ 12VAh Dry-Type Battery	
Reflektif / Reflective	Reflektif Folyo Üzeri Transparan Kaplama	Reflective Transparent Covered	
Ağırlık / Weight	18 kg	18 kg	



NVT 9613	İLERİ VE SAĞA MECBURİ YÖN 60 x 60 cm	ONLY AHEAD AND RIGHT 60 x 60 cm
Teknik Özellikler		Technical Specifications
Malzeme / Material	1 mm Statik Toz Boyalı Saç Kasa	1 mm Static Dyed Metal Frame
Ölçüler / Dimensions	60 x 60 x 4 cm	60 x 60 x 4 cm
Led	5 mm Şeffaf/Kırmızı/Beyaz. 8 mm Led Lensi	5 mm Colorless/Red/White. 8 mm Led
Solar Akü / Solar Battery	10W Polikristal Solar/ 12V7Ah Kuru Tip Akü	10W Polycrystal Solar/ 12VAh Dry-Type Battery
Reflektif / Reflective	Reflektif Folyo Üzeri Transparan Kaplama	Reflective Transparent Covered
Ağırlık / Weight	18 kg	18 kg



NVT 9614	DUR 60 x 60 cm	STOP 60 x 60 cm
Teknik Özellikler		Technical Specifications
Malzeme / Material	1 mm Statik Toz Boyalı Saç Kasa	1 mm Static Dyed Metal Frame
Ölçüler / Dimensions	60 x 60 x 4 cm	60 x 60 x 4 cm
Led	5 mm Şeffaf/Kırmızı/Beyaz. 8 mm Led Lensi	5 mm Colorless/Red/White. 8 mm Led
Solar Akü / Solar Battery	10W Polikristal Solar/ 12V7Ah Kuru Tip Akü	10W Polycrystal Solar/ 12VAh Dry-Type Battery
Reflektif / Reflective	Reflektif Folyo Üzeri Transparan Kaplama	Reflective Transparent Covered
Ağırlık / Weight	18 kg	18 kg



NVT 9615	YAVAŞ 60 x 60 cm	SLOW 60 x 60 cm
Teknik Özellikler		Technical Specifications
Malzeme / Material	1 mm Statik Toz Boyalı Saç Kasa	1 mm Static Dyed Metal Frame
Ölçüler / Dimensions	60 x 60 x 4 cm	60 x 60 x 4 cm
Led	5 mm Şeffaf/Kırmızı/Beyaz. 8 mm Led Lensi	5 mm Colorless/Red/White. 8 mm Led
Solar Akü / Solar Battery	10W Polikristal Solar/ 12V7Ah Kuru Tip Akü	10W Polycrystal Solar/ 12VAh Dry-Type Battery
Reflektif / Reflective	Reflektif Folyo Üzeri Transparan Kaplama	Reflective Transparent Covered
Ağırlık / Weight	18 kg	18 kg



NVT 9616	HIZ LİMİTİ 20 km/h 60 x 60 cm	SPEED LIMIT 20 km/h 60 x 60 cm
Teknik Özellikler		Technical Specifications
Malzeme / Material	1 mm Statik Toz Boyalı Saç Kasa	1 mm Static Dyed Metal Frame
Ölçüler / Dimensions	60 x 60 x 4 cm	60 x 60 x 4 cm
Led	5 mm Şeffaf/Kırmızı/Beyaz. 8 mm Led Lensi	5 mm Colorless/Red/White. 8 mm Led
Solar Akü / Solar Battery	10W Polikristal Solar/ 12V7Ah Kuru Tip Akü	10W Polycrystal Solar/ 12VAh Dry-Type Battery
Reflektif / Reflective	Reflektif Folyo Üzeri Transparan Kaplama	Reflective Transparent Covered
Ağırlık / Weight	18 kg	18 kg

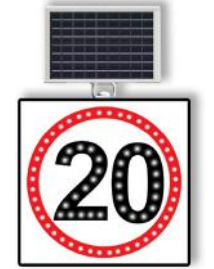

NVT 9617	HIZ LİMİTİ 30 km/h 60 x 60 cm	SPEED LIMIT 30 km/h 60 x 60 cm
Teknik Özellikler		Technical Specifications
Malzeme / Material	1 mm Statik Toz Boyalı Saç Kasa	1 mm Static Dyed Metal Frame
Ölçüler / Dimensions	60 x 60 x 4 cm	60 x 60 x 4 cm
Led	5 mm Şeffaf/Kırmızı/Beyaz. 8 mm Led Lensi	5 mm Colorless/Red/White. 8 mm Led
Solar Akü / Solar Battery	10W Polikristal Solar/ 12V7Ah Kuru Tip Akü	10W Polycrystal Solar/ 12VAh Dry-Type Battery
Reflektif / Reflective	Reflektif Folyo Üzeri Transparan Kaplama	Reflective Transparent Covered
Ağırlık / Weight	18 kg	18 kg



NVT 9618	HIZ LİMİTİ 50 km/h 60 x 60 cm	SPEED LIMIT 50 km/h 60 x 60 cm
Teknik Özellikler		Technical Specifications
Malzeme / Material	1 mm Statik Toz Boyalı Saç Kasa	1 mm Static Dyed Metal Frame
Ölçüler / Dimensions	60 x 60 x 4 cm	60 x 60 x 4 cm
Led	5 mm Şeffaf/Kırmızı/Beyaz. 8 mm Led Lensi	5 mm Colorless/Red/White. 8 mm Led
Solar Akü / Solar Battery	10W Polikristal Solar/ 12V7Ah Kuru Tip Akü	10W Polycrystal Solar/ 12VAh Dry-Type Battery
Reflektif / Reflective	Reflektif Folyo Üzeri Transparan Kaplama	Reflective Transparent Covered
Ağırlık / Weight	18 kg	18 kg





NVT 9619	HIZ LİMİTİ 70 km/h 60 x 60 cm	SPEED LIMIT 70 km/h 60 x 60 cm
Teknik Özellikler		Technical Specifications
Malzeme / Material	1 mm Statik Toz Boyalı Saç Kasa	1 mm Static Dyed Metal Frame
Ölçüler / Dimensions	60 x 60 x 4 cm	60 x 60 x 4 cm
Led	5 mm Şeffaf/Kırmızı/Beyaz. 8 mm Led Lensi	5 mm Colorless/Red/White. 8 mm Led
Solar Akü / Solar Battery	10W Polikristal Solar/ 12V7Ah Kuru Tip Akü	10W Polycrystal Solar/ 12VAh Dry-Type Battery
Reflektif / Reflective	Reflektif Folyo Üzeri Transparan Kaplama	Reflective Transparent Covered
Ağırlık / Weight	18 kg	18 kg



NVT 9620	HIZ LİMİTİ 90 km/h 60 x 60 cm	SPEED LIMIT 90 km/h 60 x 60 cm
Teknik Özellikler		Technical Specifications
Malzeme / Material	1 mm Statik Toz Boyalı Saç Kasa	1 mm Static Dyed Metal Frame
Ölçüler / Dimensions	60 x 60 x 4 cm	60 x 60 x 4 cm
Led	5 mm Şeffaf/Kırmızı/Beyaz. 8 mm Led Lensi	5 mm Colorless/Red/White. 8 mm Led
Solar Akü / Solar Battery	10W Polikristal Solar/ 12V7Ah Kuru Tip Akü	10W Polycrystal Solar/ 12VAh Dry-Type Battery
Reflektif / Reflective	Reflektif Folyo Üzeri Transparan Kaplama	Reflective Transparent Covered
Ağırlık / Weight	18 kg	18 kg



NVT 9621	ÇALIŞMA VAR 60 x 60 cm	ROADWORK 60 x 60 cm
Teknik Özellikler		Technical Specifications
Malzeme / Material	1 mm Statik Toz Boyalı Saç Kasa	1 mm Static Dyed Metal Frame
Ölçüler / Dimensions	60 x 60 x 4 cm	60 x 60 x 4 cm
Led	5 mm Şeffaf/Kırmızı/Beyaz. 8 mm Led Lensi	5 mm Colorless/Red/White. 8 mm Led
Solar Akü / Solar Battery	10W Polikristal Solar/ 12V7Ah Kuru Tip Akü	10W Polycrystal Solar/ 12VAh Dry-Type Battery
Reflektif / Reflective	Reflektif Folyo Üzeri Transparan Kaplama	Reflective Transparent Covered
Ağırlık / Weight	18 kg	18 kg



NVT 9622	DİKKAT ŞANTIYE ÇIKIŞI 60 x 60 cm	ATTENTION CONSTRUCTION EXIT 60 x 60 cm
Teknik Özellikler		Technical Specifications
Malzeme / Material	1 mm Statik Toz Boyalı Saç Kasa	1 mm Static Dyed Metal Frame
Ölçüler / Dimensions	60 x 60 x 4 cm	60 x 60 x 4 cm
Led	5 mm Şeffaf/Kırmızı/Beyaz. 8 mm Led Lensi	5 mm Colorless/Red/White. 8 mm Led
Solar Akü / Solar Battery	10W Polikristal Solar/ 12V7Ah Kuru Tip Akü	10W Polycrystal Solar/ 12VAh Dry-Type Battery
Reflektif / Reflective	Reflektif Folyo Üzeri Transparan Kaplama	Reflective Transparent Covered
Ağırlık / Weight	18 kg	18 kg



NVT 9623	DİKKAT ARAÇ ÇIKABİLİR 60 x 60 cm	ATTENTION VEHICLE EXIT 60 x 60 cm
Teknik Özellikler		Technical Specifications
Malzeme / Material	1 mm Statik Toz Boyalı Saç Kasa	1 mm Static Dyed Metal Frame
Ölçüler / Dimensions	60 x 60 x 4 cm	60 x 60 x 4 cm
Led	5 mm Şeffaf/Kırmızı/Beyaz. 8 mm Led Lensi	5 mm Colorless/Red/White. 8 mm Led
Solar Akü / Solar Battery	10W Polikristal Solar/ 12V7Ah Kuru Tip Akü	10W Polycrystal Solar/ 12VAh Dry-Type Battery
Reflektif / Reflective	Reflektif Folyo Üzeri Transparan Kaplama	Reflective Transparent Covered
Ağırlık / Weight	18 kg	18 kg



NVT 9624	KAMYON ARKASI ÇİFT YÖNLÜ OK 60 x 60 cm	DIRECTION ARROW FOR TRUCK TWO 60 x 60 cm
Teknik Özellikler		Technical Specifications
Malzeme / Material	1 mm Statik Toz Boyalı Saç Kasa	1 mm Static Dyed Metal Frame
Ölçüler / Dimensions	60 x 60 x 4 cm	60 x 60 x 4 cm
Led	5 mm Şeffaf/Kırmızı/Beyaz. 8 mm Led Lensi	5 mm Colorless/Red/White. 8 mm Led
Solar Akü / Solar Battery	10W Polikristal Solar/ 12V7Ah Kuru Tip Akü	10W Polycrystal Solar/ 12VAh Dry-Type Battery
Reflektif / Reflective	Reflektif Folyo Üzeri Transparan Kaplama	Reflective Transparent Covered
Ağırlık / Weight	18 kg	18 kg



NVT 9625	SAĞA TEHLİKELİ VİRAJ 60 x 60 cm	DANGEROUS BEND TO RIGHT 60 x 60 cm
Teknik Özellikler		Technical Specifications
Malzeme / Material	1 mm Statik Toz Boyalı Saç Kasa	1 mm Static Dyed Metal Frame
Ölçüler / Dimensions	60 x 60 x 4 cm	60 x 60 x 4 cm
Led	5 mm Şeffaf/Kırmızı/Beyaz. 8 mm Led Lensi	5 mm Colorless/Red/White. 8 mm Led
Solar Akü / Solar Battery	10W Polikristal Solar/ 12V7Ah Kuru Tip Akü	10W Polycrystal Solar/ 12VAh Dry-Type Battery
Reflektif / Reflective	Reflektif Folyo Üzeri Transparan Kaplama	Reflective Transparent Covered
Ağırlık / Weight	18 kg	18 kg



NVT 9626	SOLA TEHLİKELİ VİRAJ 60 x 60 cm	DANGEROUS BEND TO LEFT 60 x 60 cm
Teknik Özellikler		Technical Specifications
Malzeme / Material	1 mm Statik Toz Boyalı Saç Kasa	1 mm Static Dyed Metal Frame
Ölçüler / Dimensions	60 x 60 x 4 cm	60 x 60 x 4 cm
Led	5 mm Şeffaf/Kırmızı/Beyaz. 8 mm Led Lensi	5 mm Colorless/Red/White. 8 mm Led
Solar Akü / Solar Battery	10W Polikristal Solar/ 12V7Ah Kuru Tip Akü	10W Polycrystal Solar/ 12VAh Dry-Type Battery
Reflektif / Reflective	Reflektif Folyo Üzeri Transparan Kaplama	Reflective Transparent Covered
Ağırlık / Weight	18 kg	18 kg

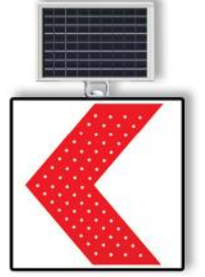

NVT 9627	GİRİLMEZ 60 x 60 cm	NO ENTRY 60 x 60 cm
Teknik Özellikler		Technical Specifications
Malzeme / Material	1 mm Statik Toz Boyalı Saç Kasa	1 mm Static Dyed Metal Frame
Ölçüler / Dimensions	60 x 60 x 4 cm	60 x 60 x 4 cm
Led	5 mm Şeffaf/Kırmızı/Beyaz. 8 mm Led Lensi	5 mm Colorless/Red/White. 8 mm Led
Solar Akü / Solar Battery	10W Polikristal Solar/ 12V7Ah Kuru Tip Akü	10W Polycrystal Solar/ 12VAh Dry-Type Battery
Reflektif / Reflective	Reflektif Folyo Üzeri Transparan Kaplama	Reflective Transparent Covered
Ağırlık / Weight	18 kg	18 kg



NVT 9628	OKUL GEÇİDİ 60 x 60 cm	SCHOOL 60 x 60 cm
Teknik Özellikler		Technical Specifications
Malzeme / Material	1 mm Statik Toz Boyalı Saç Kasa	1 mm Static Dyed Metal Frame
Ölçüler / Dimensions	60 x 60 x 4 cm	60 x 60 x 4 cm
Led	5 mm Şeffaf/Kırmızı/Beyaz. 8 mm Led Lensi	5 mm Colorless/Red/White. 8 mm Led
Solar Akü / Solar Battery	10W Polikristal Solar/ 12V7Ah Kuru Tip Akü	10W Polycrystal Solar/ 12VAh Dry-Type Battery
Reflektif / Reflective	Reflektif Folyo Üzeri Transparan Kaplama	Reflective Transparent Covered
Ağırlık / Weight	18 kg	18 kg



NVT 9629	DİKKAT TRAFİK KONTROL 60 x 60 cm	ATTENTION TRAFFIC CONTROL 60 x 60 cm
Teknik Özellikler		Technical Specifications
Malzeme / Material	1 mm Statik Toz Boyalı Saç Kasa	1 mm Static Dyed Metal Frame
Ölçüler / Dimensions	60 x 60 x 4 cm	60 x 60 x 4 cm
Led	5 mm Şeffaf/Kırmızı/Beyaz. 8 mm Led Lensi	5 mm Colorless/Red/White. 8 mm Led
Solar Akü / Solar Battery	10W Polikristal Solar/ 12V7Ah Kuru Tip Akü	10W Polycrystal Solar/ 12VAh Dry-Type Battery
Reflektif / Reflective	Reflektif Folyo Üzeri Transparan Kaplama	Reflective Transparent Covered
Ağırlık / Weight	18 kg	18 kg



NVT 9630	GEVŞEK ZEMİNLİ YOL 60 x 60 cm	STONES ROAD 60 x 60 cm
Teknik Özellikler		Technical Specifications
Malzeme / Material	1 mm Statik Toz Boyalı Saç Kasa	1 mm Static Dyed Metal Frame
Ölçüler / Dimensions	60 x 60 x 4 cm	60 x 60 x 4 cm
Led	5 mm Şeffaf/Kırmızı/Beyaz. 8 mm Led Lensi	5 mm Colorless/Red/White. 8 mm Led
Solar Akü / Solar Battery	10W Polikristal Solar/ 12V7Ah Kuru Tip Akü	10W Polycrystal Solar/ 12VAh Dry-Type Battery
Reflektif / Reflective	Reflektif Folyo Üzeri Transparan Kaplama	Reflective Transparent Covered
Ağırlık / Weight	18 kg	18 kg



NVT 9631	DİKKAT FABRİKA ÇIKIŞI 60 x 60 cm	ATTENTION FACTORY EXIT 60 x 60 cm
Teknik Özellikler		Technical Specifications
Malzeme / Material	1 mm Statik Toz Boyalı Saç Kasa	1 mm Static Dyed Metal Frame
Ölçüler / Dimensions	60 x 60 x 4 cm	60 x 60 x 4 cm
Led	5 mm Şeffaf/Kırmızı/Beyaz. 8 mm Led Lensi	5 mm Colorless/Red/White. 8 mm Led
Solar Akü / Solar Battery	10W Polikristal Solar/ 12V7Ah Kuru Tip Akü	10W Polycrystal Solar/ 12VAh Dry-Type Battery
Reflektif / Reflective	Reflektif Folyo Üzeri Transparan Kaplama	Reflective Transparent Covered
Ağırlık / Weight	18 kg	18 kg



NVT 9632	YAVAŞ ÇİFT YÖNLÜ OK 60 x 60 cm	SLOW WITH TWO ARROWS 60 x 60 cm
Teknik Özellikler		Technical Specifications
Malzeme / Material	1 mm Statik Toz Boyalı Saç Kasa	1 mm Static Dyed Metal Frame
Ölçüler / Dimensions	60 x 60 x 4 cm	60 x 60 x 4 cm
Led	5 mm Şeffaf/Kırmızı/Beyaz. 8 mm Led Lensi	5 mm Colorless/Red/White. 8 mm Led
Solar Akü / Solar Battery	10W Polikristal Solar/ 12V7Ah Kuru Tip Akü	10W Polycrystal Solar/ 12VAh Dry-Type Battery
Reflektif / Reflective	Reflektif Folyo Üzeri Transparan Kaplama	Reflective Transparent Covered
Ağırlık / Weight	18 kg	18 kg



NVT 9633	YAVAŞ ÇİFT YÖNLÜ OK 100 x 100 cm	SLOW WITH TWO ARROWS 100 x 100 cm
Teknik Özellikler		Technical Specifications
Malzeme / Material	1.2 mm Statik Toz Boyalı Saç Kasa	1.2 mm Static Dyed Metal Frame
Ölçüler / Dimensions	100 x 100 x 4 cm	100 x 100 x 4 cm
Led	5 mm Şeffaf/Kırmızı/Beyaz. 8 mm Led Lensi	5 mm Colorless/Red/White. 8 mm Led
Solar Akü / Solar Battery	10W Polikristal Solar/ 12V7Ah Kuru Tip Akü	10W Polycrystal Solar/ 12VAh Dry-Type Battery
Reflektif / Reflective	Reflektif Folyo Üzeri Transparan Kaplama	Reflective Transparent Covered
Ağırlık / Weight	30 kg	30 kg

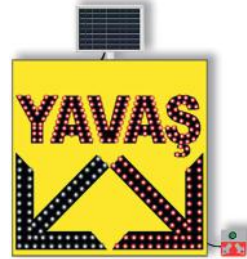

NVT 9634	HIZ LİMİTİ 20 km/h SARI ZEMİN 100 x 100 cm	SPEED LIMIT 20 km/h 100 x 100 cm
Teknik Özellikler		Technical Specifications
Malzeme / Material	1.2 mm Statik Toz Boyalı Saç Kasa	1.2 mm Static Dyed Metal Frame
Ölçüler / Dimensions	100 x 100 x 4 cm	100 x 100 x 4 cm
Led	5 mm Şeffaf/Kırmızı/Beyaz. 8 mm Led Lensi	5 mm Colorless/Red/White. 8 mm Led
Solar Akü / Solar Battery	10W Polikristal Solar/ 12V7Ah Kuru Tip Akü	10W Polycrystal Solar/ 12VAh Dry-Type Battery
Reflektif / Reflective	Reflektif Folyo Üzeri Transparan Kaplama	Reflective Transparent Covered
Ağırlık / Weight	29 kg	29 kg



NVT 9635	HIZ LİMİTİ 30 km/h SARI ZEMİN 100 x 100 cm	SPEED LIMIT 30 km/h 100 x 100 cm
Teknik Özellikler		Technical Specifications
Malzeme / Material	1.2 mm Statik Toz Boyalı Saç Kasa	1.2 mm Static Dyed Metal Frame
Ölçüler / Dimensions	100 x 100 x 4 cm	100 x 100 x 4 cm
Led	5 mm Şeffaf/Kırmızı/Beyaz. 8 mm Led Lensi	5 mm Colorless/Red/White. 8 mm Led
Solar Akü / Solar Battery	10W Polikristal Solar/ 12V7Ah Kuru Tip Akü	10W Polycrystal Solar/ 12VAh Dry-Type Battery
Reflektif / Reflective	Reflektif Folyo Üzeri Transparan Kaplama	Reflective Transparent Covered
Ağırlık / Weight	29 kg	29 kg



NVT 9636	HIZ LİMİTİ 50 km/h SARI ZEMİN 100 x 100 cm	SPEED LIMIT 50 km/h 100 x 100 cm
Teknik Özellikler		Technical Specifications
Malzeme / Material	1.2 mm Statik Toz Boyalı Saç Kasa	1.2 mm Static Dyed Metal Frame
Ölçüler / Dimensions	100 x 100 x 4 cm	100 x 100 x 4 cm
Led	5 mm Şeffaf/Kırmızı/Beyaz. 8 mm Led Lensi	5 mm Colorless/Red/White. 8 mm Led
Solar Akü / Solar Battery	10W Polikristal Solar/ 12V7Ah Kuru Tip Akü	10W Polycrystal Solar/ 12VAh Dry-Type Battery
Reflektif / Reflective	Reflektif Folyo Üzeri Transparan Kaplama	Reflective Transparent Covered
Ağırlık / Weight	29 kg	29 kg



NVT 9637	HIZ LİMİTİ 70 km/h SARI ZEMİN 100 x 100 cm	SPEED LIMIT 70 km/h 100 x 100 cm
Teknik Özellikler		Technical Specifications
Malzeme / Material	1.2 mm Statik Toz Boyalı Saç Kasa	1.2 mm Static Dyed Metal Frame
Ölçüler / Dimensions	100 x 100 x 4 cm	100 x 100 x 4 cm
Led	5 mm Şeffaf/Kırmızı/Beyaz. 8 mm Led Lensi	5 mm Colorless/Red/White. 8 mm Led
Solar Akü / Solar Battery	10W Polikristal Solar/ 12V7Ah Kuru Tip Akü	10W Polycrystal Solar/ 12VAh Dry-Type Battery
Reflektif / Reflective	Reflektif Folyo Üzeri Transparan Kaplama	Reflective Transparent Covered
Ağırlık / Weight	29 kg	29 kg



NVT 9638	HIZ LİMİTİ 90 km/h SARI ZEMİN 100 x 100 cm	SPEED LIMIT 90 km/h 100 x 100 cm
Teknik Özellikler		Technical Specifications
Malzeme / Material	1.2 mm Statik Toz Boyalı Saç Kasa	1.2 mm Static Dyed Metal Frame
Ölçüler / Dimensions	100 x 100 x 4 cm	100 x 100 x 4 cm
Led	5 mm Şeffaf/Kırmızı/Beyaz. 8 mm Led Lensi	5 mm Colorless/Red/White. 8 mm Led
Solar Akü / Solar Battery	10W Polikristal Solar/ 12V7Ah Kuru Tip Akü	10W Polycrystal Solar/ 12VAh Dry-Type Battery
Reflektif / Reflective	Reflektif Folyo Üzeri Transparan Kaplama	Reflective Transparent Covered
Ağırlık / Weight	29 kg	29 kg



NVT 9639	SAĞA MECBURİ YÖN SARI ZEMİN 100 x 100 cm	KEEP RIGHT 100 x 100 cm
Teknik Özellikler		Technical Specifications
Malzeme / Material	1.2 mm Statik Toz Boyalı Saç Kasa	1.2 mm Static Dyed Metal Frame
Ölçüler / Dimensions	100 x 100 x 4 cm	100 x 100 x 4 cm
Led	5 mm Şeffaf/Kırmızı/Beyaz. 8 mm Led Lensi	5 mm Colorless/Red/White. 8 mm Led
Solar Akü / Solar Battery	10W Polikristal Solar/ 12V7Ah Kuru Tip Akü	10W Polycrystal Solar/ 12VAh Dry-Type Battery
Reflektif / Reflective	Reflektif Folyo Üzeri Transparan Kaplama	Reflective Transparent Covered
Ağırlık / Weight	29 kg	29 kg



NVT 9640	SOLA MECBURİ YÖN SARI ZEMİN 100 x 100 cm	KEEP LEFT 100 x 100 cm
Teknik Özellikler		Technical Specifications
Malzeme / Material	1.2 mm Statik Toz Boyalı Saç Kasa	1.2 mm Static Dyed Metal Frame
Ölçüler / Dimensions	100 x 100 x 4 cm	100 x 100 x 4 cm
Led	5 mm Şeffaf/Kırmızı/Beyaz. 8 mm Led Lensi	5 mm Colorless/Red/White. 8 mm Led
Solar Akü / Solar Battery	10W Polikristal Solar/ 12V7Ah Kuru Tip Akü	10W Polycrystal Solar/ 12VAh Dry-Type Battery
Reflektif / Reflective	Reflektif Folyo Üzeri Transparan Kaplama	Reflective Transparent Covered
Ağırlık / Weight	29 kg	29 kg

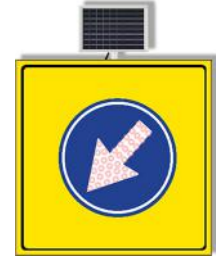

NVT 9641	YOLDA ÇALIŞMA VAR SARI ZEMİN 100 x 100 cm	ROADWORK 100 x 100 cm
Teknik Özellikler		Technical Specifications
Malzeme / Material	1.2 mm Statik Toz Boyalı Saç Kasa	1.2 mm Static Dyed Metal Frame
Ölçüler / Dimensions	100 x 100 x 4 cm	100 x 100 x 4 cm
Led	5 mm Şeffaf/Kırmızı/Beyaz. 8 mm Led Lensi	5 mm Colorless/Red/White. 8 mm Led
Solar Akü / Solar Battery	10W Polikristal Solar/ 12V7Ah Kuru Tip Akü	10W Polycrystal Solar/ 12VAh Dry-Type Battery
Reflektif / Reflective	Reflektif Folyo Üzeri Transparan Kaplama	Reflective Transparent Covered
Ağırlık / Weight	29 kg	29 kg

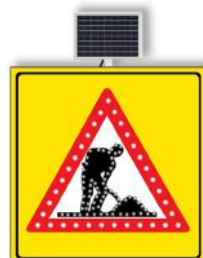

NVT 9642	SOLLAMA YASAK SARI ZEMİN 100 x 100 cm	NO OVERTAKING 100 x 100 cm
Teknik Özellikler		Technical Specifications
Malzeme / Material	1.2 mm Statik Toz Boyalı Saç Kasa	1.2 mm Static Dyed Metal Frame
Ölçüler / Dimensions	100 x 100 x 4 cm	100 x 100 x 4 cm
Led	5 mm Şeffaf/Kırmızı/Beyaz. 8 mm Led Lensi	5 mm Colorless/Red/White. 8 mm Led
Solar Akü / Solar Battery	10W Polikristal Solar/ 12V7Ah Kuru Tip Akü	10W Polycrystal Solar/ 12VAh Dry-Type Battery
Reflektif / Reflective	Reflektif Folyo Üzeri Transparan Kaplama	Reflective Transparent Covered
Ağırlık / Weight	29 kg	29 kg



NVT 9643	DİKKAT FABRİKA ÇIKIŞI 100 x 100 cm	ATTENTION FACTORY EXIT 100 x 100 cm
Teknik Özellikler		Technical Specifications
Malzeme / Material	1.2 mm Statik Toz Boyalı Saç Kasa	1.2 mm Static Dyed Metal Frame
Ölçüler / Dimensions	100 x 100 x 4 cm	100 x 100 x 4 cm
Led	5 mm Şeffaf/Kırmızı/Beyaz. 8 mm Led Lensi	5 mm Colorless/Red/White. 8 mm Led
Solar Akü / Solar Battery	10W Polikristal Solar/ 12V7Ah Kuru Tip Akü	10W Polycrystal Solar/ 12VAh Dry-Type Battery
Reflektif / Reflective	Reflektif Folyo Üzeri Transparan Kaplama	Reflective Transparent Covered
Ağırlık / Weight	29 kg	29 kg



NVT 9644	DİKKAT ŞANTİYE ÇIKIŞI 100 x 100 cm	ATTENTION CONSTRUCTION EXIT 100 x 100 cm
Teknik Özellikler		Technical Specifications
Malzeme / Material	1.2 mm Statik Toz Boyalı Saç Kasa	1.2 mm Static Dyed Metal Frame
Ölçüler / Dimensions	100 x 100 x 4 cm	100 x 100 x 4 cm
Led	5 mm Şeffaf/Kırmızı/Beyaz. 8 mm Led Lensi	5 mm Colorless/Red/White. 8 mm Led
Solar Akü / Solar Battery	10W Polikristal Solar/ 12V7Ah Kuru Tip Akü	10W Polycrystal Solar/ 12VAh Dry-Type Battery
Reflektif / Reflective	Reflektif Folyo Üzeri Transparan Kaplama	Reflective Transparent Covered
Ağırlık / Weight	29 kg	29 kg



NVT 9645	ŞERİT AKTARIMI SAĞ YOLDAN SOL YOLA 110 x 120 cm	CHANGING LANE FROM RIGHT TO LEFT 110 x 120 cm
Teknik Özellikler		Technical Specifications
Malzeme / Material	1.2 mm Statik Toz Boyalı Saç Kasa	1.2 mm Static Dyed Metal Frame
Ölçüler / Dimensions	110 x 120 x 4 cm	110 x 120 x 4 cm
Led	5 mm Şeffaf/Kırmızı/Beyaz. 8 mm Led Lensi	5 mm Colorless/Red/White. 8 mm Led
Solar Akü / Solar Battery	10W Polikristal Solar/ 12V7Ah Kuru Tip Akü	10W Polycrystal Solar/ 12VAh Dry-Type Battery
Reflektif / Reflective	Reflektif Folyo Üzeri Transparan Kaplama	Reflective Transparent Covered
Ağırlık / Weight	30,5 kg	30,5 kg

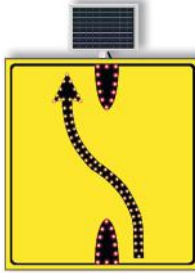

NVT 9646	ŞERİT AKTARIMI SOL YOLDAN SAĞ YOLA 110 x 120 cm	CHANGING LANE FROM LEFT TO RIGHT 110 x 120 cm
Teknik Özellikler		Technical Specifications
Malzeme / Material	1.2 mm Statik Toz Boyalı Saç Kasa	1.2 mm Static Dyed Metal Frame
Ölçüler / Dimensions	110 x 120 x 4 cm	110 x 120 x 4 cm
Led	5 mm Şeffaf/Kırmızı/Beyaz. 8 mm Led Lensi	5 mm Colorless/Red/White. 8 mm Led
Solar Akü / Solar Battery	10W Polikristal Solar/ 12V7Ah Kuru Tip Akü	10W Polycrystal Solar/ 12VAh Dry-Type Battery
Reflektif / Reflective	Reflektif Folyo Üzeri Transparan Kaplama	Reflective Transparent Covered
Ağırlık / Weight	30,5 kg	30,5 kg

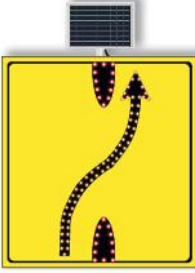

NVT 9647	ŞERİT AKTARIMI ÇİFTLİ SAĞ YOLDAN SOL YOLA 110 x 120 cm	CHANGING LANES FROM RIGHT TO LEFT 110 x 120 cm
Teknik Özellikler		Technical Specifications
Malzeme / Material	1.2 mm Statik Toz Boyalı Saç Kasa	1.2 mm Static Dyed Metal Frame
Ölçüler / Dimensions	110 x 120 x 4 cm	110 x 120 x 4 cm
Led	5 mm Şeffaf/Kırmızı/Beyaz. 8 mm Led Lensi	5 mm Colorless/Red/White. 8 mm Led
Solar Akü / Solar Battery	10W Polikristal Solar/ 12V7Ah Kuru Tip Akü	10W Polycrystal Solar/ 12VAh Dry-Type Battery
Reflektif / Reflective	Reflektif Folyo Üzeri Transparan Kaplama	Reflective Transparent Covered
Ağırlık / Weight	30,5 kg	30,5 kg



NVT 9648	ŞERİT AKTARIMI ÇİFTLİ SOL YOLDAN SAĞ YOLA 110 x 120 cm	CHANGING LANES FROM LEFT TO RIGHT 110 x 120 cm
Teknik Özellikler		Technical Specifications
Malzeme / Material	1.2 mm Statik Toz Boyalı Saç Kasa	1.2 mm Static Dyed Metal Frame
Ölçüler / Dimensions	110 x 120 x 4 cm	110 x 120 x 4 cm
Led	5 mm Şeffaf/Kırmızı/Beyaz. 8 mm Led Lensi	5 mm Colorless/Red/White. 8 mm Led
Solar Akü / Solar Battery	10W Polikristal Solar/ 12V7Ah Kuru Tip Akü	10W Polycrystal Solar/ 12VAh Dry-Type Battery
Reflektif / Reflective	Reflektif Folyo Üzeri Transparan Kaplama	Reflective Transparent Covered
Ağırlık / Weight	30,5 kg	30,5 kg



NVT 9649	DARALAN YOL SOL YOLDAN SAĞ YOLA 110 x 120 cm	NARROWING LANE FROM LEFT 110 x 120 cm
Teknik Özellikler		Technical Specifications
Malzeme / Material	1.2 mm Statik Toz Boyalı Saç Kasa	1.2 mm Static Dyed Metal Frame
Ölçüler / Dimensions	110 x 120 x 4 cm	110 x 120 x 4 cm
Led	5 mm Şeffaf/Kırmızı/Beyaz. 8 mm Led Lensi	5 mm Colorless/Red/White. 8 mm Led
Solar Akü / Solar Battery	10W Polikristal Solar/ 12V7Ah Kuru Tip Akü	10W Polycrystal Solar/ 12VAh Dry-Type Battery
Reflektif / Reflective	Reflektif Folyo Üzeri Transparan Kaplama	Reflective Transparent Covered
Ağırlık / Weight	30,5 kg	30,5 kg

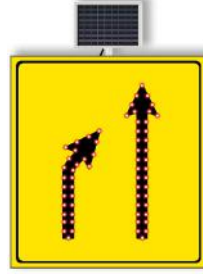

NVT 9650	DARALAN YOL SAĞ YOLDAN SOL YOLA 110 x 120 cm	NARROWING LANE FROM RIGHT 110 x 120 cm
Teknik Özellikler		Technical Specifications
Malzeme / Material	1.2 mm Statik Toz Boyalı Saç Kasa	1.2 mm Static Dyed Metal Frame
Ölçüler / Dimensions	110 x 120 x 4 cm	110 x 120 x 4 cm
Led	5 mm Şeffaf/Kırmızı/Beyaz. 8 mm Led Lensi	5 mm Colorless/Red/White. 8 mm Led
Solar Akü / Solar Battery	10W Polikristal Solar/ 12V7Ah Kuru Tip Akü	10W Polycrystal Solar/ 12VAh Dry-Type Battery
Reflektif / Reflective	Reflektif Folyo Üzeri Transparan Kaplama	Reflective Transparent Covered
Ağırlık / Weight	30,5 kg	30,5 kg

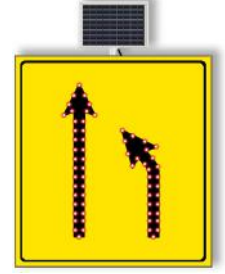

NVT 9651	SOLLAMA YASAK LED'Lİ HIZ LİMİTİ 50 km/h LED'SİZ SARI ZEMİN 100 x 175 cm	SOLAR NO OVERTAKING AND SPEED LIMIT 50km/h WITHOUT SOLAR 100 x 175 cm
Teknik Özellikler		Technical Specifications
Malzeme / Material	1.2 mm Statik Toz Boyalı Saç Kasa	1.2 mm Static Dyed Metal Frame
Ölçüler / Dimensions	100 x 175 x 4 cm	100 x 175 x 4 cm
Led	5 mm Şeffaf/Kırmızı/Beyaz. 8 mm Led Lensi	5 mm Colorless/Red/White. 8 mm Led
Solar Akü / Solar Battery	10W Polikristal Solar/ 12V7Ah Kuru Tip Akü	10W Polycrystal Solar/ 12VAh Dry-Type Battery
Reflektif / Reflective	Reflektif Folyo Üzeri Transparan Kaplama	Reflective Transparent Covered
Ağırlık / Weight	33,5 kg	33,5 kg



NVT 9652	SOLLAMA YASAK LED'Lİ HIZ LİMİTİ 70 km/h LED'SİZ SARI ZEMİN 100 x 175 cm	SOLAR NO OVERTAKING AND SPEED LIMIT 70km/h WITHOUT SOLAR 100 x 175 cm
Teknik Özellikler		Technical Specifications
Malzeme / Material	1.2 mm Statik Toz Boyalı Saç Kasa	1.2 mm Static Dyed Metal Frame
Ölçüler / Dimensions	100 x 175 x 4 cm	100 x 175 x 4 cm
Led	5 mm Şeffaf/Kırmızı/Beyaz. 8 mm Led Lensi	5 mm Colorless/Red/White. 8 mm Led
Solar Akü / Solar Battery	10W Polikristal Solar/ 12V7Ah Kuru Tip Akü	10W Polycrystal Solar/ 12VAh Dry-Type Battery
Reflektif / Reflective	Reflektif Folyo Üzeri Transparan Kaplama	Reflective Transparent Covered
Ağırlık / Weight	33,5 kg	33,5 kg



NVT 9653	DİKKAT FABRİKA ÇIKIŞI 60 x 180 cm	CHANGING LANES FROM RIGHT TO LEFT 110 x 120 cm
Teknik Özellikler		Technical Specifications
Malzeme / Material	1.2 mm Statik Toz Boyalı Saç Kasa	1.2 mm Static Dyed Metal Frame
Ölçüler / Dimensions	60 x 180 x 4 cm	60 x 180 x 4 cm
Led	5 mm Şeffaf/Kırmızı/Beyaz. 8 mm Led Lensi	5 mm Colorless/Red/White. 8 mm Led
Solar Akü / Solar Battery	10W Polikristal Solar/ 12V7Ah Kuru Tip Akü	10W Polycrystal Solar/ 12VAh Dry-Type Battery
Reflektif / Reflective	Reflektif Folyo Üzeri Transparan Kaplama	Reflective Transparent Covered
Ağırlık / Weight	38 kg	38 kg



NVT 9654	SOLLAMA YASAK LED'Lİ HIZ LİMİTİ 70 km/h LED'Lİ SARI ZEMİN 100 x 204 cm	SOLAR NO OVERTAKING AND SPEED LIMIT 70km/h SOLAR 100 x 204 cm
Teknik Özellikler		Technical Specifications
Malzeme / Material	1.2 mm Statik Toz Boyalı Saç Kasa	1.2 mm Static Dyed Metal Frame
Ölçüler / Dimensions	100 x 204 x 4 cm	100 x 204 x 4 cm
Led	5 mm Şeffaf/Kırmızı/Beyaz. 8 mm Led Lensi	5 mm Colorless/Red/White. 8 mm Led
Solar Akü / Solar Battery	10W Polikristal Solar/ 12V7Ah Kuru Tip Akü	10W Polycrystal Solar/ 12VAh Dry-Type Battery
Reflektif / Reflective	Reflektif Folyo Üzeri Transparan Kaplama	Reflective Transparent Covered
Ağırlık / Weight	35,5 kg	35,5 kg



NVT 9655	SOLLAMA YASAK LED'Lİ HIZ LİMİTİ 50 km/h LED'Lİ SARI ZEMİN 100 x 204 cm	SOLAR NO OVERTAKING AND SPEED LIMIT 50km/h SOLAR 100 x 204 cm
Teknik Özellikler		Technical Specifications
Malzeme / Material	1.2 mm Statik Toz Boyalı Saç Kasa	1.2 mm Static Dyed Metal Frame
Ölçüler / Dimensions	100 x 204 x 4 cm	100 x 204 x 4 cm
Led	5 mm Şeffaf/Kırmızı/Beyaz. 8 mm Led Lensi	5 mm Colorless/Red/White. 8 mm Led
Solar Akü / Solar Battery	10W Polikristal Solar/ 12V7Ah Kuru Tip Akü	10W Polycrystal Solar/ 12VAh Dry-Type Battery
Reflektif / Reflective	Reflektif Folyo Üzeri Transparan Kaplama	Reflective Transparent Covered
Ağırlık / Weight	35,5 kg	35,5 kg



NVT 9656	HIZ LİMİTİ 70 km/h GELİŞ GİDİŞ YOL SARI ZEMİN 100 x 204 cm	SPEED LIMIT 70 km/h AND TWO WAYS 100 x 204 cm
Teknik Özellikler		Technical Specifications
Malzeme / Material	1.2 mm Statik Toz Boyalı Saç Kasa	1.2 mm Static Dyed Metal Frame
Ölçüler / Dimensions	100 x 204 x 4 cm	100 x 204 x 4 cm
Led	5 mm Şeffaf/Kırmızı/Beyaz. 8 mm Led Lensi	5 mm Colorless/Red/White. 8 mm Led
Solar Akü / Solar Battery	10W Polikristal Solar/ 12V7Ah Kuru Tip Akü	10W Polycrystal Solar/ 12VAh Dry-Type Battery
Reflektif / Reflective	Reflektif Folyo Üzeri Transparan Kaplama	Reflective Transparent Covered
Ağırlık / Weight	35,5 kg	35,5 kg



NVT 9657	SAĞA TEHLİKELİ VİRAJ 60 x 180 cm	DANGEROUS BEND TO RIGHT 180 x 60 cm
Teknik Özellikler		Technical Specifications
Malzeme / Material	1.2 mm Statik Toz Boyalı Saç Kasa	1.2 mm Static Dyed Metal Frame
Ölçüler / Dimensions	60 x 180 x 4 cm	60 x 180 x 4 cm
Led	5 mm Şeffaf/Kırmızı/Beyaz. 8 mm Led Lensi	5 mm Colorless/Red/White. 8 mm Led
Solar Akü / Solar Battery	10W Polikristal Solar/ 12V7Ah Kuru Tip Akü	10W Polycrystal Solar/ 12VAh Dry-Type Battery
Reflektif / Reflective	Reflektif Folyo Üzeri Transparan Kaplama	Reflective Transparent Covered
Ağırlık / Weight	40 kg	40 kg



NVT 9658	SOLA TEHLİKELİ VİRAJ 60 x 180 cm	DANGEROUS BEND TO LEFT 180 x 60 cm
Teknik Özellikler		Technical Specifications
Malzeme / Material	1.2 mm Statik Toz Boyalı Saç Kasa	1.2 mm Static Dyed Metal Frame
Ölçüler / Dimensions	60 x 180 x 4 cm	60 x 180 x 4 cm
Led	5 mm Şeffaf/Kırmızı/Beyaz. 8 mm Led Lensi	5 mm Colorless/Red/White. 8 mm Led
Solar Akü / Solar Battery	10W Polikristal Solar/ 12V7Ah Kuru Tip Akü	10W Polycrystal Solar/ 12VAh Dry-Type Battery
Reflektif / Reflective	Reflektif Folyo Üzeri Transparan Kaplama	Reflective Transparent Covered
Ağırlık / Weight	40 kg	40 kg



**X NEVA**  
**SOLAR**







5 WP POLY PANEL	5 WP POLY PANEL
Teknik Özellikler / Technical Specifications	
Model Tipi / Model Type	TT5-18P
Maximum Güç (Pmax) / Peak Power (Pmax)	5 Wp
Maximum Güç Gerilimi (Vmp) / Maximum Power Voltage (Vmp)	9,86
Maximum Güç Akımı (Imp) / Maximum Power Current (Imp)	0,51
Açık Devre Gerilimi (Voc) / Open Circuit Voltage (Voc)	11,61
Kısa Devre Akımı (Isc) / Short Circuit Current (Isc)	0,54
Panel Boyutu / Panel Dimensions	204x254x16
Ağırlık / Weight	0,64



6 WP POLY PANEL	6 WP POLY PANEL
Teknik Özellikler / Technical Specifications	
Model Tipi / Model Type	TT6-18PM
Maximum Güç (Pmax) / Peak Power (Pmax)	6 Wp
Maximum Güç Gerilimi (Vmp) / Maximum Power Voltage (Vmp)	10,40
Maximum Güç Akımı (Imp) / Maximum Power Current (Imp)	0,60
Açık Devre Gerilimi (Voc) / Open Circuit Voltage (Voc)	12,20
Kısa Devre Akımı (Isc) / Short Circuit Current (Isc)	0,63
Panel Boyutu / Panel Dimensions	204x254x16
Ağırlık / Weight	0,64



10 WP POLY PANEL	10 WP POLY PANEL
Teknik Özellikler / Technical Specifications	
Model Tipi / Model Type	TT10-36P
Maximum Güç (Pmax) / Peak Power (Pmax)	10 Wp
Maximum Güç Gerilimi (Vmp) / Maximum Power Voltage (Vmp)	19,73
Maximum Güç Akımı (Imp) / Maximum Power Current (Imp)	0,51
Açık Devre Gerilimi (Voc) / Open Circuit Voltage (Voc)	23,22
Kısa Devre Akımı (Isc) / Short Circuit Current (Isc)	0,54
Panel Boyutu / Panel Dimensions	254x364x16
Ağırlık / Weight	1,4



22 WP POLY PANEL	22 WP POLY PANEL
Teknik Özellikler / Technical Specifications	
Model Tipi / Model Type	TT22-36P
Maximum Güç (Pmax) / Peak Power (Pmax)	22 Wp
Maximum Güç Gerilimi (Vmp) / Maximum Power Voltage (Vmp)	19,73
Maximum Güç Akımı (Imp) / Maximum Power Current (Imp)	1,12
Açık Devre Gerilimi (Voc) / Open Circuit Voltage (Voc)	23,22
Kısa Devre Akımı (Isc) / Short Circuit Current (Isc)	1,19
Panel Boyutu / Panel Dimensions	359x419x16
Ağırlık / Weight	1,75



42 WP POLY PANEL	42 WP POLY PANEL
Teknik Özellikler / Technical Specifications	
Model Tipi / Model Type	TT42-36P
Maximum Güç (Pmax) / Peak Power (Pmax)	42 Wp
Maximum Güç Gerilimi (Vmp) / Maximum Power Voltage (Vmp)	19,73
Maximum Güç Akımı (Imp) / Maximum Power Current (Imp)	2,13
Açık Devre Gerilimi (Voc) / Open Circuit Voltage (Voc)	23,22
Kısa Devre Akımı (Isc) / Short Circuit Current (Isc)	2,26
Panel Boyutu / Panel Dimensions	424x674x20
Ağırlık / Weight	3



50 WP POLY PANEL	50 WP POLY PANEL
Teknik Özellikler / Technical Specifications	
Model Tipi / Model Type	TT50-36PM
Maximum Güç (Pmax) / Peak Power (Pmax)	50 Wp
Maximum Güç Gerilimi (Vmp) / Maximum Power Voltage (Vmp)	20,74
Maximum Güç Akımı (Imp) / Maximum Power Current (Imp)	2,42
Açık Devre Gerilimi (Voc) / Open Circuit Voltage (Voc)	24,40
Kısa Devre Akımı (Isc) / Short Circuit Current (Isc)	2,55
Panel Boyutu / Panel Dimensions	424x674x20
Ağırlık / Weight	3



65 WP POLY PANEL	65 WP POLY PANEL
Teknik Özellikler / Technical Specifications	
Model Tipi / Model Type	TT65-36PM
Maximum Güç (Pmax) / Peak Power (Pmax)	65 Wp
Maximum Güç Gerilimi (Vmp) / Maximum Power Voltage (Vmp)	20,74
Maximum Güç Akımı (Imp) / Maximum Power Current (Imp)	3,14
Açık Devre Gerilimi (Voc) / Open Circuit Voltage (Voc)	24,40
Kısa Devre Akımı (Isc) / Short Circuit Current (Isc)	3,31
Panel Boyutu / Panel Dimensions	554x674x20
Ağırlık / Weight	4



85 WP POLY PANEL	85 WP POLY PANEL
Teknik Özellikler / Technical Specifications	
Model Tipi / Model Type	TT85-36P
Maximum Güç (Pmax) / Peak Power (Pmax)	85 Wp
Maximum Güç Gerilimi (Vmp) / Maximum Power Voltage (Vmp)	19,73
Maximum Güç Akımı (Imp) / Maximum Power Current (Imp)	4,31
Açık Devre Gerilimi (Voc) / Open Circuit Voltage (Voc)	23,22
Kısa Devre Akımı (Isc) / Short Circuit Current (Isc)	4,51
Panel Boyutu / Panel Dimensions	674x784x20
Ağırlık / Weight	7,4



95 WP MONO PANEL	95 WP MONO PANEL
Teknik Özellikler / Technical Specifications	
Model Tipi / Model Type	TT95-36PM
Maximum Güç (Pmax) / Peak Power (Pmax)	95 Wp
Maximum Güç Gerilimi (Vmp) / Maximum Power Voltage (Vmp)	20,74
Maximum Güç Akımı (Imp) / Maximum Power Current (Imp)	4,59
Açık Devre Gerilimi (Voc) / Open Circuit Voltage (Voc)	24,40
Kısa Devre Akımı (Isc) / Short Circuit Current (Isc)	4,84
Panel Boyutu / Panel Dimensions	674x784x20
Ağırlık / Weight	7,4

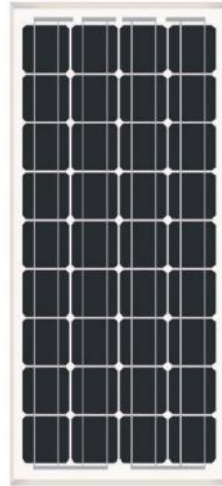

105 WP POLY PANEL	105 WP POLY PANEL
Teknik Özellikler / Technical Specifications	
Model Tipi / Model Type	TT105-36P
Maximum Güç (Pmax) / Peak Power (Pmax)	105 Wp
Maximum Güç Gerilimi (Vmp) / Maximum Power Voltage (Vmp)	19,73
Maximum Güç Akımı (Imp) / Maximum Power Current (Imp)	5,33
Açık Devre Gerilimi (Voc) / Open Circuit Voltage (Voc)	23,22
Kısa Devre Akımı (Isc) / Short Circuit Current (Isc)	5,58
Panel Boyutu / Panel Dimensions	674x944x20
Ağırlık / Weight	9



120 WP POLY PANEL	120 WP POLY PANEL
Teknik Özellikler / Technical Specifications	
Model Tipi / Model Type	TT120-36PM
Maximum Güç (Pmax) / Peak Power (Pmax)	120 Wp
Maximum Güç Gerilimi (Vmp) / Maximum Power Voltage (Vmp)	20,74
Maximum Güç Akımı (Imp) / Maximum Power Current (Imp)	5,79
Açık Devre Gerilimi (Voc) / Open Circuit Voltage (Voc)	24,40
Kısa Devre Akımı (Isc) / Short Circuit Current (Isc)	6,10
Panel Boyutu / Panel Dimensions	674x944x20
Ağırlık / Weight	9



170 WP MONO PANEL	170 WP MONO PANEL
Teknik Özellikler / Technical Specifications	
Model Tipi / Model Type	TT170-36P
Maximum Güç (Pmax) / Peak Power (Pmax)	170 Wp
Maximum Güç Gerilimi (Vmp) / Maximum Power Voltage (Vmp)	19,73
Maximum Güç Akımı (Imp) / Maximum Power Current (Imp)	8,62
Açık Devre Gerilimi (Voc) / Open Circuit Voltage (Voc)	23,22
Kısa Devre Akımı (Isc) / Short Circuit Current (Isc)	9,02
Panel Boyutu / Panel Dimensions	1488x675x30
Ağırlık / Weight	10,8



NEVA LIGHT

NEVA PARK

NEVA TRAFİK

NEVA SOLAR

190 WP MONO PANEL	190 WP MONO PANEL
Teknik Özellikler / Technical Specifications	
Model Tipi / Model Type	TT190-36PM
Maximum Güç (Pmax) / Peak Power (Pmax)	190 Wp
Maximum Güç Gerilimi (Vmp) / Maximum Power Voltage (Vmp)	20,74
Maximum Güç Akımı (Imp) / Maximum Power Current (Imp)	9,20
Açık Devre Gerilimi (Voc) / Open Circuit Voltage (Voc)	24,40
Kısa Devre Akımı (Isc) / Short Circuit Current (Isc)	9,82
Panel Boyutu / Panel Dimensions	1488x675x30
Ağırlık / Weight	10,8



270 WP POLY PANEL	270 WP POLY PANEL
Teknik Özellikler / Technical Specifications	
Model Tipi / Model Type	TT270-60P
Maximum Güç (Pmax) / Peak Power (Pmax)	270 Wp
Maximum Güç Gerilimi (Vmp) / Maximum Power Voltage (Vmp)	31,00
Maximum Güç Akımı (Imp) / Maximum Power Current (Imp)	8,71
Açık Devre Gerilimi (Voc) / Open Circuit Voltage (Voc)	38,00
Kısa Devre Akımı (Isc) / Short Circuit Current (Isc)	9,21
Panel Boyutu / Panel Dimensions	1648x995x35
Ağırlık / Weight	18



275 WP POLY PANEL	275 WP POLY PANEL
Teknik Özellikler / Technical Specifications	
Model Tipi / Model Type	TT275-60P
Maximum Güç (Pmax) / Peak Power (Pmax)	275 Wp
Maximum Güç Gerilimi (Vmp) / Maximum Power Voltage (Vmp)	31,30
Maximum Güç Akımı (Imp) / Maximum Power Current (Imp)	8,79
Açık Devre Gerilimi (Voc) / Open Circuit Voltage (Voc)	38,40
Kısa Devre Akımı (Isc) / Short Circuit Current (Isc)	9,31
Panel Boyutu / Panel Dimensions	1648x995x35
Ağırlık / Weight	18



280 WP MONO PANEL	280 WP MONO PANEL
Teknik Özellikler / Technical Specifications	
Model Tipi / Model Type	TT280-60P
Maximum Güç (Pmax) / Peak Power (Pmax)	280 Wp
Maximum Güç Gerilimi (Vmp) / Maximum Power Voltage (Vmp)	31,60
Maximum Güç Akımı (Imp) / Maximum Power Current (Imp)	8,87
Açık Devre Gerilimi (Voc) / Open Circuit Voltage (Voc)	38,70
Kısa Devre Akımı (Isc) / Short Circuit Current (Isc)	9,39
Panel Boyutu / Panel Dimensions	1648x995x35
Ağırlık / Weight	18



280 WP POLY PANEL	280 WP POLY PANEL
Teknik Özellikler / Technical Specifications	
Model Tipi / Model Type	TT280-60P
Maximum Güç (Pmax) / Peak Power (Pmax)	280 Wp
Maximum Güç Gerilimi (Vmp) / Maximum Power Voltage (Vmp)	31,60
Maximum Güç Akımı (Imp) / Maximum Power Current (Imp)	8,87
Açık Devre Gerilimi (Voc) / Open Circuit Voltage (Voc)	38,70
Kısa Devre Akımı (Isc) / Short Circuit Current (Isc)	9,39
Panel Boyutu / Panel Dimensions	1648x995x35
Ağırlık / Weight	18



300 WP MONO PANEL	300 WP MONO PANEL
Teknik Özellikler / Technical Specifications	
Model Tipi / Model Type	TT300-60M
Maximum Güç (Pmax) / Peak Power (Pmax)	300 Wp
Maximum Güç Gerilimi (Vmp) / Maximum Power Voltage (Vmp)	33,42
Maximum Güç Akımı (Imp) / Maximum Power Current (Imp)	9,02
Açık Devre Gerilimi (Voc) / Open Circuit Voltage (Voc)	38,95
Kısa Devre Akımı (Isc) / Short Circuit Current (Isc)	9,54
Panel Boyutu / Panel Dimensions	1648x995x35
Ağırlık / Weight	18



300 WP POLY PANEL	300 WP POLY PANEL
Teknik Özellikler / Technical Specifications	
Model Tipi / Model Type	TT300-60M
Maximum Güç (Pmax) / Peak Power (Pmax)	300 Wp
Maximum Güç Gerilimi (Vmp) / Maximum Power Voltage (Vmp)	33,42
Maximum Güç Akımı (Imp) / Maximum Power Current (Imp)	9,02
Açık Devre Gerilimi (Voc) / Open Circuit Voltage (Voc)	38,95
Kısa Devre Akımı (Isc) / Short Circuit Current (Isc)	9,54
Panel Boyutu / Panel Dimensions	1648x995x35
Ağırlık / Weight	18



310 WP POLY PANEL	310 WP POLY PANEL
Teknik Özellikler / Technical Specifications	
Model Tipi / Model Type	TT310-60PM
Maximum Güç (Pmax) / Peak Power (Pmax)	310 Wp
Maximum Güç Gerilimi (Vmp) / Maximum Power Voltage (Vmp)	33,08
Maximum Güç Akımı (Imp) / Maximum Power Current (Imp)	9,38
Açık Devre Gerilimi (Voc) / Open Circuit Voltage (Voc)	39,06
Kısa Devre Akımı (Isc) / Short Circuit Current (Isc)	10,03
Panel Boyutu / Panel Dimensions	1648x995x35
Ağırlık / Weight	18

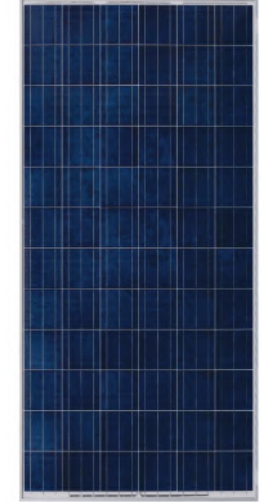

325 WP MONO PANEL	325 WP MONO PANEL
Teknik Özellikler / Technical Specifications	
Model Tipi / Model Type	TT325-60PM
Maximum Güç (Pmax) / Peak Power (Pmax)	325 Wp
Maximum Güç Gerilimi (Vmp) / Maximum Power Voltage (Vmp)	33,31
Maximum Güç Akımı (Imp) / Maximum Power Current (Imp)	9,76
Açık Devre Gerilimi (Voc) / Open Circuit Voltage (Voc)	39,28
Kısa Devre Akımı (Isc) / Short Circuit Current (Isc)	10,45
Panel Boyutu / Panel Dimensions	1648x995x35
Ağırlık / Weight	18



325 WP POLY PANEL	325 WP POLY PANEL
Teknik Özellikler / Technical Specifications	
Model Tipi / Model Type	TT325-60PM
Maximum Güç (Pmax) / Peak Power (Pmax)	325 Wp
Maximum Güç Gerilimi (Vmp) / Maximum Power Voltage (Vmp)	33,31
Maximum Güç Akımı (Imp) / Maximum Power Current (Imp)	9,76
Açık Devre Gerilimi (Voc) / Open Circuit Voltage (Voc)	39,28
Kısa Devre Akımı (Isc) / Short Circuit Current (Isc)	10,45
Panel Boyutu / Panel Dimensions	1648x995x35
Ağırlık / Weight	18



360 WP MONO PANEL	360 WP MONO PANEL
Teknik Özellikler / Technical Specifications	
Model Tipi / Model Type	TT360-72M
Maximum Güç (Pmax) / Peak Power (Pmax)	360 Wp
Maximum Güç Gerilimi (Vmp) / Maximum Power Voltage (Vmp)	39,78
Maximum Güç Akımı (Imp) / Maximum Power Current (Imp)	9,06
Açık Devre Gerilimi (Voc) / Open Circuit Voltage (Voc)	46,45
Kısa Devre Akımı (Isc) / Short Circuit Current (Isc)	9,59
Panel Boyutu / Panel Dimensions	1959x995x40
Ağırlık / Weight	22



395 WP MONO PANEL	395 WP MONO PANEL
Teknik Özellikler / Technical Specifications	
Model Tipi / Model Type	TT395-72PM
Maximum Güç (Pmax) / Peak Power (Pmax)	395 Wp
Maximum Güç Gerilimi (Vmp) / Maximum Power Voltage (Vmp)	41,33
Maximum Güç Akımı (Imp) / Maximum Power Current (Imp)	9,57
Açık Devre Gerilimi (Voc) / Open Circuit Voltage (Voc)	48,17
Kısa Devre Akımı (Isc) / Short Circuit Current (Isc)	10,06
Panel Boyutu / Panel Dimensions	1984x1007x40
Ağırlık / Weight	22



NEVA LIGHT

NEVA PARK

NEVA TRAFİK

NEVA SOLAR

1 KW AKILLI INVERTER	1 KW SMART INVERTER
Teknik Özellikler / Technical Specifications	
Model / Model	VTS 1000
Anma Gücü / Rated Power	1000VA/1000
Voltaj / Voltage	230 VAC
Frekans Aralığı / Frequency Range	50 Hz/60 Hz
Dalgalanma Gücü / Surge Power	2000 VA
Batarya Voltajı / Battery Voltage	12 VDC
Yüzer Şarj Gerilimi / Floating Charge Voltage	13,5 VDC
Aşırı Şarj Koruması / Overcharge Protection	16 VDC
Solar Şarj Cihazı Çeşiti / Solar Charge Type	PWM
Maksimum PV Dizisi Açık Devre Gerilimi / Max. PV Array Open Circuit Voltage	55 VDC
Maksimum Solar Şarj Akımı / Max. Solar Charge Current	50 A
Maksimum Şarj Akımı / Max. Charge Current	50 A
Boyut / Dimension	225x88x320
Net Ağırlık / Weight	5 Kg



3 KW AKILLI INVERTER	3 KW SMART INVERTER
Teknik Özellikler / Technical Specifications	
Model / Model	VTS 3000
Anma Gücü / Rated Power	3000VA/3000W
Voltaj / Voltage	230VAC
Frekans Aralığı / Frequency Range	50 Hz / 60 Hz
Dalgalanma Gücü / Surge Power	3000 VA
Batarya Voltajı / Battery Voltage	24 VDC
Yüzer Şarj Gerilimi / Floating Charge Voltage	27 VDC
Aşırı Şarj Koruması / Overcharge Protection	32 VDC
Solar Şarj Cihazı Çeşiti / Solar Charge Type	PWM
Maksimum PV Dizisi Açık Devre Gerilimi / Max. PV Array Open Circuit Voltage	80 VDC
Maksimum Solar Şarj Akımı / Max. Solar Charge Current	50 A
Maksimum Şarj Akımı / Max. Charge Current	70 A
Boyut / Dimension	285x100x334
Net Ağırlık / Weight	6,3 Kg.



5 KW AKILLI INVERTER	5 KW SMART INVERTER
Teknik Özellikler / Technical Specifications	
Model / Model	VTS 5000
Anma Gücü / Rated Power	5000 VA / 5000 W
Voltaj / Voltage	230 VAC
Frekans Aralığı / Frequency Range	50 Hz / 80 Hz
Dalgalanma Gücü / Surge Power	10000 VA
Batarya Voltajı / Battery Voltage	48 VDC
Yüzer Şarj Gerilimi / Floating Charge Voltage	54 VDC
Aşırı Şarj Koruması / Overcharge Protection	63 VDC
Solar Şarj Cihazı Çeşiti / Solar Charge Type	PWM
Maksimum PV Dizisi Açık Devre Gerilimi / Max. PV Array Open Circuit Voltage	105 VDC
Maksimum Solar Şarj Akımı / Max. Solar Charge Current	50 A
Maksimum Şarj Akımı / Max. Charge Current	110 A
Boyut / Dimension	300x100x440
Net Ağırlık / Weight	8,5 Kg.



10 KW AKILLI INVERTER	10 KW SMART INVERTER
Teknik Özellikler / Technical Specifications	
Model / Model	VTS 10000
Anma Gücü / Rated Power	10000 VA / 10000 W
Voltaj / Voltage	380 VAC
Frekans Aralığı / Frequency Range	50 Hz / 60 Hz
Dalgalanma Gücü / Surge Power	10000 VA
Batarya Voltajı / Battery Voltage	48 VDC
Yüzer Şarj Gerilimi / Floating Charge Voltage	54 VDC
Aşırı Şarj Koruması / Overcharge Protection	63 VDC
Solar Şarj Cihazı Çeşiti / Solar Charge Type	MPPT
Maksimum PV Dizisi Açık Devre Gerilimi / Max. PV Array Open Circuit Voltage	900 VDC
Maksimum Solar Şarj Akımı / Max. Solar Charge Current	60 A
Maksimum Şarj Akımı / Max. Charge Current	200 A
Boyut / Dimension	167,5x500x622
Net Ağırlık / Weight	45 Kg.



300 W MODİFİYE SİNÜS	300 W MODIFIED SINE
Teknik Özellikler / Technical Specifications	
Güç / Power	300 W
Max. Çıkış Gücü / Peak (5Sn.)	600 W
Giriş Voltajı / Input Voltage	12 V / 24 V DC
Çıkış Voltajı / Output Voltage	220 V AC
Kare Dalga	Modified Sine Wave



600 W MODİFİYE SİNÜS	600 W MODIFIED SINE
Teknik Özellikler / Technical Specifications	
Güç / Power	600 W
Max. Çıkış Gücü / Peak (5Sn.)	1200 W
Giriş Voltajı / Input Voltage	12 V / 24 V DC
Çıkış Voltajı / Output Voltage	220 V AC
Kare Dalga	Modified Sine Wave



1000 W MODİFİYE SİNÜS	1000 W MODIFIED SINE
Teknik Özellikler / Technical Specifications	
Güç / Power	1000 W
Max. Çıkış Gücü / Peak (5Sn.)	2000 W
Giriş Voltajı / Input Voltage	12 V / 24 V DC
Çıkış Voltajı / Output Voltage	220 V AC
Kare Dalga	Modified Sine Wave



1200 W MODİFİYE SİNÜS	1200 W MODIFIED SINE
Teknik Özellikler / Technical Specifications	
Güç / Power	1200 W
Max. Çıkış Gücü / Peak (5Sn.)	2400 W
Giriş Voltajı / Input Voltage	12 V / 24 V DC
Çıkış Voltajı / Output Voltage	220 V AC
Kare Dalga	Modified Sine Wave



1500 W MODİFİYE SİNÜS	1500 W MODIFIED SINE
Teknik Özellikler / Technical Specifications	
Güç / Power	1500 W
Max. Çıkış Gücü / Peak (5Sn.)	3000 W
Giriş Voltajı / Input Voltage	12 V / 24 V DC
Çıkış Voltajı / Output Voltage	220 V AC
Kare Dalga	Modified Sine Wave



2000 W MODİFİYE SİNÜS	2000 W MODIFIED SINE
Teknik Özellikler / Technical Specifications	
Güç / Power	2000 W
Max. Çıkış Gücü / Peak (5Sn.)	4000 W
Giriş Voltajı / Input Voltage	12 V / 24 V DC
Çıkış Voltajı / Output Voltage	220 V AC
Kare Dalga	Modified Sine Wave



2500 W MODİFİYE SİNÜS	2500 W MODIFIED SINE
Teknik Özellikler / Technical Specifications	
Güç / Power	2500 W
Max. Çıkış Gücü / Peak (5Sn.)	5000 W
Giriş Voltajı / Input Voltage	12 V / 24 V DC
Çıkış Voltajı / Output Voltage	220 V AC
Kare Dalga	Modified Sine Wave



4000 W MODİFİYE SİNÜS	4000 W MODIFIED SINE
Teknik Özellikler / Technical Specifications	
Güç / Power	4000 W
Max. Çıkış Gücü / Peak (5Sn.)	8000 W
Giriş Voltajı / Input Voltage	12 V / 24 V DC
Çıkış Voltajı / Output Voltage	220 V AC
Kare Dalga	Modified Sine Wave





600 W TAM SİNÜS	600 W FULL SINE
Teknik Özellikler / <i>Technical Specifications</i>	
Güç / ?	600 W
Peak (5 Sn) / ?	1200 W
Giriş Voltajı / ?	12 V / 24 V DC
Çıkış Voltajı / ?	220 V AC
Tam Sinüs Dalga	Full Sine Wave



1000 W TAM SİNÜS	1000 W FULL SINE
Teknik Özellikler / <i>Technical Specifications</i>	
Güç / ?	1000 W
Peak (5 Sn) / ?	2000 W
Giriş Voltajı / ?	12 V / 24 V DC
Çıkış Voltajı / ?	220 V AC
Tam Sinüs Dalga	Full Sine Wave



2000 W TAM SİNÜS	2000 W FULL SINE
Teknik Özellikler / <i>Technical Specifications</i>	
Güç / ?	2000 W
Peak (5 Sn) / ?	4000 W
Giriş Voltajı / ?	12 V / 24 V DC
Çıkış Voltajı / ?	220 V AC
Tam Sinüs Dalga	Full Sine Wave



4000 W TAM SİNÜS	4000 W FULL SINE
Teknik Özellikler / <i>Technical Specifications</i>	
Güç / ?	4000 W
Peak (5 Sn) / ?	8000 W
Giriş Voltajı / ?	12 V / 24 V DC
Çıkış Voltajı / ?	220 V AC
Tam Sinüs Dalga	Full Sine Wave



100 KTL INVERTER	100 KTL INVERTER
Teknik Özellikler / Technical Specifications	
Model / Model	SUN2000-100KTL
Maksimum Güç / Max. Power	100000 W
Giriş Voltajı / Input Voltage	1500 V
Başlangıç Voltajı / Start Voltage	650 V
Nominal Giriş Gerilimi / Nominal Input Voltage	1080 V
MPPT Başına Giriş Akımı / MPPT Operating Voltage Range	22 A
Kısa Devre Akımı / Short Circuit Current	33 A
MPP İzleyici Sayısı / Number of Inputs	12
Maks. Giriş / Max. Input	6
Şebeke Çıkışı / AC Output	Üç Faz
Nominal Çıkış Gücü / Nominal Output Voltage	100000 W
Maksimum Görünür Güç / Max. AC Apparent Power	105000 VA
Şebeke Frekansı / Rated AC Grid Frequency	50 / 60 Hz
Maksimum Çıkış Akımı / Max. Output Current	80,2 A
Ağırlık / Weight	77 Kg.
Boyut / Dimension	1075x605x310 mm.



HT 100000 INVERTER	HT 100000 INVERTER
Teknik Özellikler / Technical Specifications	
Model / Model	GW100K-HT
Maks. DC Giriş Gücü / Max. DC Input Power	150000 W
Maks. DC Giriş Voltajı / Max. DC Input Voltage	1100 V
MPPT Aralığı / MPPT Range	180-1000 V
Başlangıç Voltajı / Min. Start-up Voltage	200 V
Nominal DC Giriş Voltajı / Nominal DC Input Voltage	600 V
Maks. Giriş Akımı / Max. Input Current	10x28 A
Maks. Kısa Devre Akımı / Max. Short Current	10x42 A
MPP İzleyici Sayısı / No. Of MPP Trackers	10
İzleyici Başına Giriş Dizisi Sayısı / No. Of Input Strings Per Tracker	2
Nominal Çıkış Gücü / Nominal Output Power	100000 W
Maks. Çıkış Görünür Güç / Max. Output Apparent Power	110000 VA
Nominal Çıkış Voltajı / Nominal Output Voltage	110000 V
Nominal Çıkış Frekansı / Nominal Output Frequency	50/60 Hz
Maks. Çıkış Akımı / Max. Output Current	168 A
Ağırlık / Weight	89 kg.
Boyut / Dimension	1005x660x350 mm.



12V 100AH JEL AKÜ	12V 100AH JEL AKÜ
Teknik Özellikler / Technical Specifications	
Model / Model	12V 100AH Jel
Tip / Genus	Jel Akü
Terminal / Terminal	M8*20
Ağırlık / Weight	30 kg.
Boyut / Dimension	329x172x215 mm.



12V 150AH JEL AKÜ	12V 150AH JEL AKÜ
Teknik Özellikler / Technical Specifications	
Model / Model	12V 150AH Jel
Tip / Genus	Jel Akü
Terminal / Terminal	M8*20
Ağırlık / Weight	44 kg.
Boyut / Dimension	484x171x241 mm.



12V 200AH JEL AKÜ	12V 200AH JEL AKÜ
Teknik Özellikler / Technical Specifications	
Model / Model	12V 200AH Jel
Tip / Genus	Jel Akü
Terminal / Terminal	M8*20
Ağırlık / Weight	60 kg.
Boyut / Dimension	522x240x216 mm.



12V 28AH JEL AKÜ	12V 28AH JEL AKÜ
Teknik Özellikler / Technical Specifications	
Model / Model	12V 28AH Jel
Tip / Genus	Jel Akü
Terminal / Terminal	M6*16
Ağırlık / Weight	21 kg.
Boyut / Dimension	350x166x175 mm.



12V 33AH JEL AKÜ	12V 33AH JEL AKÜ
Teknik Özellikler / Technical Specifications	
Model / Model	12V 33AH Jel
Tip / Genus	Jel Akü
Terminal / Terminal	M6*16
Ağırlık / Weight	21 kg.
Boyut / Dimension	350x166x175 mm.



12V 42AH JEL AKÜ	12V 42AH JEL AKÜ
Teknik Özellikler / Technical Specifications	
Model / Model	12V 42AH Jel
Tip / Genus	Jel Akü
Terminal / Terminal	M6*16
Ağırlık / Weight	21 kg.
Boyut / Dimension	350x166x175 mm.



12V 65AH JEL AKÜ	12V 65AH JEL AKÜ
Teknik Özellikler / Technical Specifications	
Model / Model	12V 65AH Jel
Tip / Genus	Jel Akü
Terminal / Terminal	M6*16
Ağırlık / Weight	21 kg.
Boyut / Dimension	350x166x175 mm.



12V 14AH JEL AKÜ	12V 14AH JEL AKÜ
Teknik Özellikler / Technical Specifications	
Model / Model	12V 14AH Jel
Tip / Genus	Jel Akü
Terminal / Terminal	M5
Ağırlık / Weight	4,35 kg.
Boyut / Dimension	151x99x115 mm.



12V 22AH JEL AKÜ	12V 22AH JEL AKÜ
Teknik Özellikler / Technical Specifications	
Model / Model	12V 22AH Jel
Tip / Genus	Jel Akü
Terminal / Terminal	M5
Ağırlık / Weight	7 kg.
Boyut / Dimension	181x76x166 mm.



12V 24AH JEL AKÜ	12V 24AH JEL AKÜ
Teknik Özellikler / Technical Specifications	
Model / Model	12V 24AH Jel
Tip / Genus	Jel Akü
Terminal / Terminal	M5
Ağırlık / Weight	7,45 kg.
Boyut / Dimension	185x105x130 mm.



12V 40AH JEL AKÜ	12V 40AH JEL AKÜ
Teknik Özellikler / Technical Specifications	
Model / Model	12V 40AH Jel
Tip / Genus	Jel Akü
Terminal / Terminal	M5
Ağırlık / Weight	10,15 kg.
Boyut / Dimension	267x78x170 mm.



12V 60AH JEL AKÜ	12V 60AH JEL AKÜ
Teknik Özellikler / Technical Specifications	
Model / Model	12V 60AH Jel
Tip / Genus	Jel Akü
Terminal / Terminal	M5
Ağırlık / Weight	13,5 kg.
Boyut / Dimension	220x120x177 mm.



ŞARJ KONTROL	CHARGE CONTROL
Teknik Özellikler / Technical Specifications	
Model / Model	TT-0512E
Nominal Sistem Voltajı / Nominal System Voltage	12VDC
Anma Şarj Akımı / Rated Charge Current	5A
Anme Deşarj Akımı / Rated Discharge Current	5A
Batarya Giriş Voltajı / Battery Input Voltage Range	8V-16V
Maks. PV Açık Gerilim Voltajı / Max. PV Open Circuit Voltage	30V
Boyut / Overall Dimension	92,8x65x20,2 mm.
Ağırlık / Net Weight	0,07 kg.



ŞARJ KONTROL	CHARGE CONTROL
Teknik Özellikler / Technical Specifications	
Model / Model	TT-1012E
Nominal Sistem Voltajı / Nominal System Voltage	12VDC
Anma Şarj Akımı / Rated Charge Current	10A
Anme Deşarj Akımı / Rated Discharge Current	10A
Batarya Giriş Voltajı / Battery Input Voltage Range	8V-16V
Maks. PV Açık Gerilim Voltajı / Max. PV Open Circuit Voltage	30V
Boyut / Overall Dimension	101,2x67x21,8 mm.
Ağırlık / Net Weight	0,08 kg.



ŞARJ KONTROL	CHARGE CONTROL
Teknik Özellikler / Technical Specifications	
Model / Model	TT-1024E
Nominal Sistem Voltajı / Nominal System Voltage	12/24VDC Auto
Anma Şarj Akımı / Rated Charge Current	10A
Anme Deşarj Akımı / Rated Discharge Current	10A
Batarya Giriş Voltajı / Battery Input Voltage Range	8V-32V
Maks. PV Açık Gerilim Voltajı / Max. PV Open Circuit Voltage	50V
Boyut / Overall Dimension	101,2x67x21,8 mm.
Ağırlık / Net Weight	0,08 kg.



ŞARJ KONTROL	CHARGE CONTROL
Teknik Özellikler / Technical Specifications	
Model / Model	TT-2024E
Nominal Sistem Voltajı / Nominal System Voltage	12/24VDC Auto
Anma Şarj Akımı / Rated Charge Current	20A
Anme Deşarj Akımı / Rated Discharge Current	20A
Batarya Giriş Voltajı / Battery Input Voltage Range	8V-32V
Maks. PV Açık Gerilim Voltajı / Max. PV Open Circuit Voltage	50V
Boyut / Overall Dimension	128x85,6x34,8 mm.
Ağırlık / Net Weight	0,15 kg.



ŞARJ KONTROL	CHARGE CONTROL
Teknik Özellikler / Technical Specifications	
Model / Model	TT-3024E
Nominal Sistem Voltajı / Nominal System Voltage	12/24VDC Auto
Anma Şarj Akımı / Rated Charge Current	30A
Anme Deşarj Akımı / Rated Discharge Current	30A
Batarya Giriş Voltajı / Battery Input Voltage Range	8V-32V
Maks. PV Açık Gerilim Voltajı / Max. PV Open Circuit Voltage	50V
Boyut / Overall Dimension	148x106,8x43,7 mm.
Ağırlık / Net Weight	0,29 kg.



ŞARJ KONTROL	CHARGE CONTROL
Teknik Özellikler / Technical Specifications	
Model / Model	LS1024R
Nominal Sistem Voltajı / Nominal System Voltage	12/24VDC Auto
Anma Şarj Akımı / Rated Charge Current	10A
Anme Deşarj Akımı / Rated Discharge Current	10A
Batarya Giriş Voltajı / Battery Input Voltage Range	8V-32V
Maks. PV Açık Gerilim Voltajı / Max. PV Open Circuit Voltage	30V
Boyut / Overall Dimension	140x65x34 mm.
Ağırlık / Net Weight	0,15 kg.



ŞARJ KONTROL	CHARGE CONTROL
Teknik Özellikler / Technical Specifications	
Model / Model	LS2024R
Nominal Sistem Voltajı / Nominal System Voltage	12/24VDC Auto
Anma Şarj Akımı / Rated Charge Current	15A
Anme Deşarj Akımı / Rated Discharge Current	15A
Batarya Giriş Voltajı / Battery Input Voltage Range	8V-32V
Maks. PV Açık Gerilim Voltajı / Max. PV Open Circuit Voltage	30V
Boyut / Overall Dimension	143x75x45 mm.
Ağırlık / Net Weight	0,25 kg.



ŞARJ KONTROL	CHARGE CONTROL
Teknik Özellikler / Technical Specifications	
Model / Model	MAX Series 20
Nominal Sistem Voltajı / Nominal System Voltage	12/24/48VDC Auto
Anma Şarj Akımı / Rated Charge Current	20A
Anme Deşarj Akımı / Rated Discharge Current	20A
Batarya Giriş Voltajı / Battery Input Voltage Range	8V-32V
Maks. PV Açık Gerilim Voltajı / Max. PV Open Circuit Voltage	30V
Boyut / Overall Dimension	127x189x47 mm.
Ağırlık / Net Weight	0,55 kg.



ŞARJ KONTROL	CHARGE CONTROL
Teknik Özellikler / Technical Specifications	
Model / Model	MAX Series 30
Nominal Sistem Voltajı / Nominal System Voltage	12/24/48VDC Auto
Anma Şarj Akımı / Rated Charge Current	30A
Anme Deşarj Akımı / Rated Discharge Current	30A
Batarya Giriş Voltajı / Battery Input Voltage Range	8V-32V
Maks. PV Açık Gerilim Voltajı / Max. PV Open Circuit Voltage	50V
Boyut / Overall Dimension	127x189x47 mm.
Ağırlık / Net Weight	0,55 kg.



ŞARJ KONTROL	CHARGE CONTROL
Teknik Özellikler / Technical Specifications	
Model / Model	MAX Series 40
Nominal Sistem Voltajı / Nominal System Voltage	12/24/48VDC Auto
Anma Şarj Akımı / Rated Charge Current	40A
Anme Deşarj Akımı / Rated Discharge Current	40A
Batarya Giriş Voltajı / Battery Input Voltage Range	8V-32V
Maks. PV Açık Gerilim Voltajı / Max. PV Open Circuit Voltage	50V
Boyut / Overall Dimension	127x189x47 mm.
Ağırlık / Net Weight	0,55 kg.



ŞARJ KONTROL	CHARGE CONTROL
Teknik Özellikler / Technical Specifications	
Model / Model	SCC-MPPT 300W
Anma MPPT Çalışma Gerilimi / MPPT Range Operating Voltage	15VDC-37VDC
Maks. PV Açık Devre Gerilimi / Max. PV Array Open Circuit Voltage	50VDC
Maks. PV Açık Güç / Max. PV Array Power	300W
Nominal Batarya Voltajı / Nominal Battery Voltage	12VDC
Maks. Şarj Akımı / Max. Charging Current	25A
Boyut / Overall Dimension	135x170x57,5 mm.
Ağırlık / Net Weight	0,92 kg.



ŞARJ KONTROL	CHARGE CONTROL
Teknik Özellikler / Technical Specifications	
Model / Model	SCC-MPPT 600W
Anma MPPT Çalışma Gerilimi / MPPT Range Operating Voltage	15VDC-33VDC
Maks. PV Açık Devre Gerilimi / Max. PV Array Open Circuit Voltage	50VDC
Maks. PV Açık Güç / Max. PV Array Power	300W
Nominal Batarya Voltajı / Nominal Battery Voltage	12VDC
Maks. Şarj Akımı / Max. Charging Current	25A
Boyut / Overall Dimension	220x170x57,5 mm.
Ağırlık / Net Weight	1,85 kg.



ŞARJ KONTROL	CHARGE CONTROL
Teknik Özellikler / Technical Specifications	
Model / Model	SCC-MPPT 600W
Anma MPPT Çalışma Gerilimi / MPPT Range Operating Voltage	30VDC-66VDC
Maks. PV Açık Devre Gerilimi / Max. PV Array Open Circuit Voltage	75VDC
Maks. PV Açık Güç / Max. PV Array Power	600W
Nominal Batarya Voltajı / Nominal Battery Voltage	24VDC
Maks. Şarj Akımı / Max. Charging Current	25A
Boyut / Overall Dimension	220x170x57,5 mm.
Ağırlık / Net Weight	1,85 kg.



ŞARJ KONTROL	CHARGE CONTROL
Teknik Özellikler / Technical Specifications	
Model / Model	SCC-MPPT 3000W
Anma MPPT Çalışma Gerilimi / MPPT Range Operating Voltage	60VDC-115VDC
Maks. PV Açık Devre Gerilimi / Max. PV Array Open Circuit Voltage	145VDC
Maks. PV Açık Güç / Max. PV Array Power	800W/1600W/3200W
Nominal Batarya Voltajı / Nominal Battery Voltage	12/24/48VDC
Maks. Şarj Akımı / Max. Charging Current	60A
Boyut / Overall Dimension	315x165x128 mm.
Ağırlık / Net Weight	4,5 kg.



RX SERİSİ SÜRÜCÜLER	RX SERIES DRIVER
Teknik Özellikler / Technical Specifications	
Model / Model	RX
400V Üç Faz / 400V Three Phase	0,4 kW - 132 kW
200V Üç Faz / 200V Three Phase	0,4 kW - 55 kW
200V Tek Faz / 200V Single Phase	-
Tork Özellikleri / Torque Features	0,0 Hz'de %200 (CLV) 0,3 Hz'de %150 (CLV)



MX2 SERİSİ SÜRÜCÜLER	MX2 SERIES DRIVER
Teknik Özellikler / Technical Specifications	
Model / Model	MX2
400V Üç Faz / 400V Three Phase	0,4 kW - 15 kW
200V Üç Faz / 200V Three Phase	0,1 kW - 15 kW
200V Tek Faz / 200V Single Phase	0,1 kW - 2,2 kW
Tork Özellikleri / Torque Features	0,0 Hz'de %200 (CLV) 0,3 Hz'de %150 (CLV)



C2000 AC SERİSİ SÜRÜCÜLER	C2000 AC SERIES DRIVER
Teknik Özellikler / Technical Specifications	
Gerilim Seviyesi / Voltage Level	3x230 VAC
Güç Aralığı / Power Range	0,75 - 90 kW
Kontrol Modu / Control Mode	V/F,SVC,VF+PG,FOC+P-G,TQC+PG,PM+PG,FOC Sensorless, TQC Sensorless, PM Sensorless
Dahili Haberleşme / Internal Communication	Modbus RS-485
Haberleşme Opsiyonları / Communication Options	DeviceNet, Modbus TCP, Ether-Net/IP, Profibus DP, CANopen (DS402) ve EthetCAT
Koruma Sınıfı / Protection Class	IP20 (Operatör Paneli IP66)
Yüklenme Kapasitesi / Loading Capacity	ND*: 1 dk %120 In (5 dk), 3 sn %160 In (30 saniyede) HD*: 1 dk %150 In (5 dakikada), 3 sn %180 In (30 saniyede)
Motor Tipi / Engine Type	Asenkron Motor (IM), Sabit Miknatıslı Motor (SPM, IPM)
Çıkış Frekansı / Output Frequency	10 - 599 Hz
Giriş - Çıkış / Input - Output	10 Dijital Giriş, 3 Analog Giriş, 2 STO Girişi, 2 Analog Çıkış, 2 Röle Çıkışı, 2 Dijital Çıkış, 1 Pulse Çıkışı
Güvenlik / Security	STO SIL2 (IEC61508)



C2000 AC SERİSİ SÜRÜCÜLER	C2000 AC SERIES DRIVER
Teknik Özellikler / Technical Specifications	
Gerilim Seviyesi / Voltage Level	3x400 VAC
Güç Aralığı / Power Range	0,75 - 450 kW
Kontrol Modu / Control Mode	V/F,SVC,VF+PG,FOC+P-G,TQC+PG,PM+PG,FOC Sensorless, TQC Sensorless, PM Sensorless
Dahili Haberleşme / Internal Communication	Modbus RS-485
Haberleşme Opsiyonları / Communication Options	DeviceNet, Modbus TCP, Ether-Net/IP, Profibus DP, CANopen (DS402) ve EthetCAT
Koruma Sınıfı / Protection Class	IP20 (Operatör Paneli IP66)
Yüklenme Kapasitesi / Loading Capacity	ND*: 1 dk %120 In (5 dk), 3 sn %160 In (30 saniyede) HD*: 1 dk %150 In (5 dakikada), 3 sn %180 In (30 saniyede)
Motor Tipi / Engine Type	Asenkron Motor (IM), Sabit Miknatıslı Motor (SPM, IPM)
Çıkış Frekansı / Output Frequency	10 - 599 Hz
Giriş - Çıkış / Input - Output	10 Dijital Giriş, 3 Analog Giriş, 2 STO Girişi, 2 Analog Çıkış, 2 Röle Çıkışı, 2 Dijital Çıkış, 1 Pulse Çıkışı
Güvenlik / Security	STO SIL2 (IEC61508)



C2000 AC SERİSİ SÜRÜCÜLER	C2000 AC SERIES DRIVER
Teknik Özellikler / Technical Specifications	
Gerilim Seviyesi / Voltage Level	3x575 VAC
Güç Aralığı / Power Range	1,5 - 15 kW
Kontrol Modu / Control Mode	V/F,SVC,VF+PG,FOC+P-G,TQC+PG,PM+PG,FOC Sensorless, TQC Sensorless, PM Sensorless
Dahili Haberleşme / Internal Communication	Modbus RS-485
Haberleşme Opsiyonları / Communication Options	DeviceNet, Modbus TCP, Ether-Net/IP, Profibus DP, CANopen (DS402) ve EthetCAT
Koruma Sınıfı / Protection Class	IP20 (Operatör Paneli IP66)
Yüklenme Kapasitesi / Loading Capacity	ND*: 1 dk %120 In (5 dk), 3 sn %160 In (30 saniyede) HD*: 1 dk %150 In (5 dakikada), 3 sn %180 In (30 saniyede)
Motor Tipi / Engine Type	Asenkron Motor (IM), Sabit Miknatıslı Motor (SPM, IPM)
Çıkış Frekansı / Output Frequency	10 - 599 Hz
Giriş - Çıkış / Input - Output	10 Dijital Giriş, 3 Analog Giriş, 2 STO Girişi, 2 Analog Çıkış, 2 Röle Çıkışı, 2 Dijital Çıkış, 1 Pulse Çıkışı
Güvenlik / Security	STO SIL2 (IEC61508)



C2000 AC SERİSİ SÜRÜCÜLER	C2000 AC SERIES DRIVER
Teknik Özellikler / Technical Specifications	
Gerilim Seviyesi / Voltage Level	3x690 VAC
Güç Aralığı / Power Range	18,5 - 630 kW
Kontrol Modu / Control Mode	V/F,SVC,VF+PG,FOC+P-G,TQC+PG,PM+PG,FOC Sensorless, TQC Sensorless, PM Sensorless
Dahili Haberleşme / Internal Communication	Modbus RS-485
Haberleşme Opsiyonları / Communication Options	DeviceNet, Modbus TCP, Ether-Net/IP, Profibus DP, CANopen (DS402) ve EthetCAT
Koruma Sınıfı / Protection Class	IP20 (Operatör Paneli IP66)
Yüklenme Kapasitesi / Loading Capacity	ND*: 1 dk %120 In (5 dk), 3 sn %160 In (30 saniyede) HD*: 1 dk %150 In (5 dakikada), 3 sn %180 In (30 saniyede)
Motor Tipi / Engine Type	Asenkron Motor (IM), Sabit Miknatıslı Motor (SPM, IPM)
Çıkış Frekansı / Output Frequency	10 - 599 Hz
Giriş - Çıkış / Input - Output	10 Dijital Giriş, 3 Analog Giriş, 2 STO Girişi, 2 Analog Çıkış, 2 Röle Çıkışı, 2 Dijital Çıkış, 1 Pulse Çıkışı
Güvenlik / Security	STO SIL2 (IEC61508)





Ms300 AC SERİSİ SÜRÜCÜLER	Ms300 AC SERIES DRIVER
Teknik Özellikler / Technical Specifications	
Gerilim Seviyesi / Voltage Level	1x115 VAC
Güç Aralığı / Power Range	0,2 - 0,75 kW
Kontrol Modu / Control Mode	V/F (Scalar control), SVC (Sensorless Vector Control)
Dahili Haberleşme / Internal Communication	Modbus RS-485, USB
Haberleşme Opsiyonları / Communication Options	DeviceNet, PROFIBUS, CAN-open, EtherNET/IP, Modbus TCP, EthetCAT (yakında)
Koruma Sınıfı / Protection Class	IP20, IP40
Yüklenme Kapasitesi / Loading Capacity	ND*: 1 dakika %120 In, 3 saniye %150 In -HD*: 1 dakika %150 In, 3 saniye %200 In
Motor Tipi / Engine Type	Asenkron Motor (IM), Sabit Miknatıslı Motor (SPM, IPM)
Çıkış Frekansı / Output Frequency	0 - 599 Hz, 0 - 1500 Hz (Opsiyonel)
Giriş - Çıkış / Input - Output	7 Dijital Giriş, 2 Analog Giriş, 1 Pulse (D17)- 1 Analog Çıkış, 1 Röle Çıkışı, 2 Dijital Çıkış, 1 Pulse Çıkışı
Güvenlik / Security	STO SIL2 (IEC61508)



Ms300 AC SERİSİ SÜRÜCÜLER	Ms300 AC SERIES DRIVER
Teknik Özellikler / Technical Specifications	
Gerilim Seviyesi / Voltage Level	1x230 VAC
Güç Aralığı / Power Range	0,2 - 2,2 kW
Kontrol Modu / Control Mode	V/F (Scalar control), SVC (Sensorless Vector Control)
Dahili Haberleşme / Internal Communication	Modbus RS-485, USB
Haberleşme Opsiyonları / Communication Options	DeviceNet, PROFIBUS, CAN-open, EtherNET/IP, Modbus TCP, EthetCAT (yakında)
Koruma Sınıfı / Protection Class	IP20, IP40
Yüklenme Kapasitesi / Loading Capacity	ND*: 1 dakika %120 In, 3 saniye %150 In -HD*: 1 dakika %150 In, 3 saniye %200 In
Motor Tipi / Engine Type	Asenkron Motor (IM), Sabit Miknatıslı Motor (SPM, IPM)
Çıkış Frekansı / Output Frequency	0 - 599 Hz, 0 - 1500 Hz (Opsiyonel)
Giriş - Çıkış / Input - Output	7 Dijital Giriş, 2 Analog Giriş, 1 Pulse (D17)- 1 Analog Çıkış, 1 Röle Çıkışı, 2 Dijital Çıkış, 1 Pulse Çıkışı
Güvenlik / Security	STO SIL2 (IEC61508)



Ms300 AC SERİSİ SÜRÜCÜLER	Ms300 AC SERIES DRIVER
Teknik Özellikler / Technical Specifications	
Gerilim Seviyesi / Voltage Level	3x230 VAC
Güç Aralığı / Power Range	0,2 - 15 kW
Kontrol Modu / Control Mode	V/F (Scalar control), SVC (Sensorless Vector Control)
Dahili Haberleşme / Internal Communication	Modbus RS-485, USB
Haberleşme Opsiyonları / Communication Options	DeviceNet, PROFIBUS, CAN-open, EtherNET/IP, Modbus TCP, EthetCAT (yakında)
Koruma Sınıfı / Protection Class	IP20, IP40
Yüklenme Kapasitesi / Loading Capacity	ND*: 1 dakika %120 In, 3 saniye %150 In -HD*: 1 dakika %150 In, 3 saniye %200 In
Motor Tipi / Engine Type	Asenkron Motor (IM), Sabit Miknatıslı Motor (SPM, IPM)
Çıkış Frekansı / Output Frequency	0 - 599 Hz, 0 - 1500 Hz (Opsiyonel)
Giriş - Çıkış / Input - Output	7 Dijital Giriş, 2 Analog Giriş, 1 Pulse (D17)- 1 Analog Çıkış, 1 Röle Çıkışı, 2 Dijital Çıkış, 1 Pulse Çıkışı
Güvenlik / Security	STO SIL2 (IEC61508)



Ms300 AC SERİSİ SÜRÜCÜLER	Ms300 AC SERIES DRIVER
Teknik Özellikler / Technical Specifications	
Gerilim Seviyesi / Voltage Level	3x400 VAC
Güç Aralığı / Power Range	0,4 - 22 kW
Kontrol Modu / Control Mode	V/F (Scalar control), SVC (Sensorless Vector Control)
Dahili Haberleşme / Internal Communication	Modbus RS-485, USB
Haberleşme Opsiyonları / Communication Options	DeviceNet, PROFIBUS, CAN-open, EtherNET/IP, Modbus TCP, EthetCAT (yakında)
Koruma Sınıfı / Protection Class	IP20, IP40
Yüklenme Kapasitesi / Loading Capacity	ND*: 1 dakika %120 In, 3 saniye %150 In -HD*: 1 dakika %150 In, 3 saniye %200 In
Motor Tipi / Engine Type	Asenkron Motor (IM), Sabit Miknatıslı Motor (SPM, IPM)
Çıkış Frekansı / Output Frequency	0 - 599 Hz, 0 - 1500 Hz (Opsiyonel)
Giriş - Çıkış / Input - Output	7 Dijital Giriş, 2 Analog Giriş, 1 Pulse (D17)- 1 Analog Çıkış, 1 Röle Çıkışı, 2 Dijital Çıkış, 1 Pulse Çıkışı
Güvenlik / Security	STO SIL2 (IEC61508)



KONNEKTÖR	CONNECTOR
Teknik Özellikler / Technical Specifications	
Konnektör Sistemi / Connector System	Ø 4 mm / Ø 6 mm / Ø 10 mm
Giriş Voltajı / Rated Voltage	1000 V DC 1500 V DC
Anma Akımı / Rated Current TÜV (85°C)	22.5 A (2.5 mm <sup>2</sup> ) 39 A (4 mm <sup>2</sup> /6 mm <sup>2</sup> ) 45 A (10 mm <sup>2</sup> )
Anma Voltajı / Rated Impulse Voltage	12 kV (1000 V DC (TÜV)) 16 kV (1500 V DC (TÜV))



KONNEKTÖR	CONNECTOR
Teknik Özellikler / Technical Specifications	
Konnektör Sistemi / Connector System	Ø 4 mm / Ø 6 mm / Ø 10 mm
Giriş Voltajı / Rated Voltage	1000 V DC 1500 V DC
Anma Akımı / Rated Current TÜV (85°C)	22.5 A (2.5 mm <sup>2</sup> ) 39 A (4 mm <sup>2</sup> /6 mm <sup>2</sup> ) 45 A (10 mm <sup>2</sup> )
Anma Voltajı / Rated Impulse Voltage	12 kV (1000 V DC (TÜV)) 16 kV (1500 V DC (TÜV))



KONNEKTÖR	CONNECTOR
Teknik Özellikler / Technical Specifications	
Konnektör Sistemi / Connector System	Ø 4 mm / Ø 6 mm / Ø 10 mm
Giriş Voltajı / Rated Voltage	1000 V DC 1500 V DC
Anma Akımı / Rated Current TÜV (85°C)	22.5 A (2.5 mm <sup>2</sup> ) 39 A (4 mm <sup>2</sup> /6 mm <sup>2</sup> ) 45 A (10 mm <sup>2</sup> )
Anma Voltajı / Rated Impulse Voltage	12 kV (1000 V DC (TÜV)) 16 kV (1500 V DC (TÜV))



SOLAR KABLO	SOLAR CABLE
<i>Teknik Özellikler / Technical Specifications</i>	
İletken / Conductor	EN 60228 Class 5
Nominal Çalışma Voltajı (AC) / Nominal Operating Voltage (AC)	0,6 / 1 Kv
Maks. Çalışma Voltajı (DC) / Operating Voltage Max. (DC)	1.8 Kv
Alev İlerlemesi / Flame Propagation	EN 60332 - 3 - 24 CAT C
Ürün Ömrü / Expected Life Time	25 YIL



SOLAR KABLO	SOLAR CABLE
<i>Teknik Özellikler / Technical Specifications</i>	
İletken / Conductor	EN 60228 Class 5
Nominal Çalışma Voltajı (AC) / Nominal Operating Voltage (AC)	0,6 / 1 Kv
Maks. Çalışma Voltajı (DC) / Operating Voltage Max. (DC)	1.8 Kv
Alev İlerlemesi / Flame Propagation	EN 60332 - 3 - 24 CAT C
Ürün Ömrü / Expected Life Time	25 YIL



### SPB-500W

#### Teknik Özellikler / Technical Specification

Solar Panel	Solar Panel	18V / 60Wp / 3,33A Mono Crystall
Solar Panel Boyutu	Solar Panel Dimensions	560*675*28mm
Pil	Jel Akü	12V / 42Ah Solar Jel Akü
Led	LED	12V / 7W / 475 lümen A+
İnverter	Modified Sinus	12V-220V 300watt
Solar Şarj Kontrol	Solar Charge Controller	12V/24V/20A

#### NELER ÇALIŞTIRIR?

	GÜÇ (W)	ADET	ÇALIŞMA SÜRESİ (SAAT)	GÜNLÜK TÜKETİM(W)
AYDINLATMA	7	2	5	70
TELEFON ŞARJI	10	1	2	20
BİLGİSAYAR ŞARJI	135	1	1	135



**Tukey**  
Discover  
the potential



### SPB-750W

#### Teknik Özellikler / Technical Specification

Solar Panel	Solar Panel	2*18V / 60Wp / 3,33A Mono Crystall
Solar Panel Boyutu	Solar Panel Dimensions	2*(560*675*28)mm
Pil	Jel Akü	12V / 65Ah Solar Jel Akü
Led	Led	12V 7W 475 lümen A+
İnverter	Modified Sinus	12V-220V 300Watt
Solar Şarj Kontrol	Solar Charge Controller	12V/24V/20A

#### NELER ÇALIŞTIRIR?

	GÜÇ (W)	ADET	ÇALIŞMA SÜRESİ (SAAT)	GÜNLÜK TÜKETİM(W)
AYDINLATMA	7	2	5	70
TELEFON ŞARJI	10	1	2	20
BİLGİSAYAR ŞARJI	135	1	1	135
TELEVİZYON	75	1	5	375

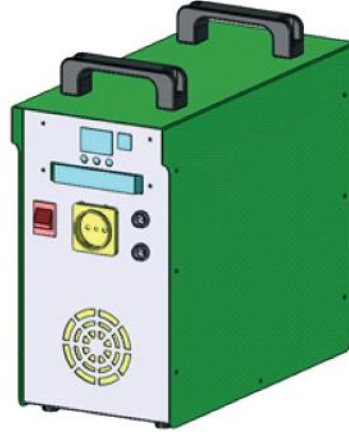

**Tukey**  
Discover  
the potential



### SPB-2400W

#### Teknik Özellikler / Technical Specification

Solar Panel	Solar Panel	2*(19,69V / 8,54A / 170W)
Solar Panel Boyutu	Solar Panel Dimensions	2*(1494*679*35)mm
Pil	Jel Akü	2*(12V / 100Ah)
Led	Led	3*(12V 7W 475 lümen) A+
İnverter	Modified Sinus	12V-220V 1000watt
Solar Şarj Kontrol	Solar Charge Controller	12V/24V/20A

#### NELER ÇALIŞTIRIR?

	GÜÇ (W)	ADET	ÇALIŞMA SÜRESİ (SAAT)	GÜNLÜK TÜKETİM(W)
AYDINLATMA	7	2	5	70
TELEFON ŞARJI	10	1	2	20
BİLGİSAYAR ŞARJI	135	1	1	135
TELEVİZYON	50	1	8	400
MİNİ BUZDOLABI	600	1	24/Gün	600



**Tukey**  
Discover  
the potential



### SPB-3600W

#### Teknik Özellikler / Technical Specification

Solar Panel	Solar Panel	2*(19,69V / 8,54A / 170W)
Solar Panel Boyutu	Solar Panel Dimensions	2*(1494*679*35)mm
Pil	Jel Akü	2*(12V / 150Ah)
İnverter	Akıllı İnverter	24V-220V 3kVA

#### NELER ÇALIŞTIRIR?

	GÜÇ (W)	ADET	ÇALIŞMA SÜRESİ (SAAT)	GÜNLÜK TÜKETİM(W)
AYDINLATMA	7	2	5	70
TELEFON ŞARJI	10	1	2	20
BİLGİSAYAR ŞARJI	135	1	1	135
TELEVİZYON	50	1	8	400
MİNİ BUZDOLABI	600	1	24/Gün	600

### SPB-7200W

#### Teknik Özellikler / Technical Specification

Solar Panel	Solar Panel	4*(31,3V / 8,79A / 275W)
Solar Panel Boyutu	Solar Panel Dimensions	4*(1648*995*35)mm
Pil	Jel Akü	4*(12V / 150Ah)
İnverter	Akıllı İnverter	24V-220V 3kVA

#### NELER ÇALIŞTIRIR?

	GÜÇ (W)	ADET	ÇALIŞMA SÜRESİ (SAAT)	GÜNLÜK TÜKETİM(W)
AYDINLATMA	7	5	6	210
TELEFON ŞARJI	10	2	2	40
BİLGİSAYAR ŞARJI	135	1	2	270
TELEVİZYON	50	1	10	500
MİNİ BUZDOLABI	600	1	24/Gün	600
VANTİLATÖR	50	1	6	300
A+ 5 kg ÇAM. MAK.	800	1	1	800



Discover the potential

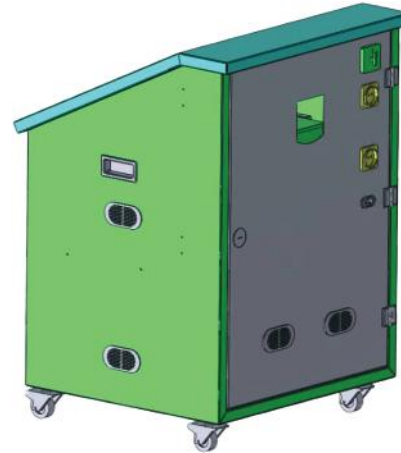

Discover the potential



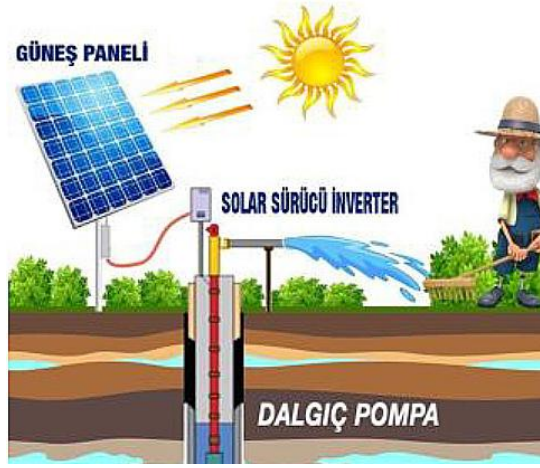

### POMPA PAKET SİSTEMLERİ (0,75 Hp)

#### Paket nelerden oluşur?

- 10 Adet Polikristal Panel 275W
- 1 Adet 1.5 kW Solar Sulama Driver
- 1 Set Konstrüksiyon
- 20 Metre DC Solar Kablo

#### Teknik Detaylar;

Pompa Beygir Gücü: 0,75 hp  
Pompa Gücü: 0,5 kW  
Çalışma Voltajı: 220V  
Faz: 1 (Monofaz)

### POMPA PAKET SİSTEMLERİ (1,5 Hp)

#### Paket nelerden oluşur?

- 11 Adet Polikristal Panel 275W
- 1 Adet 2.2 kW Solar Sulama Driver
- 1 Set Konstrüksiyon
- 20 Metre DC Solar Kablo

#### Teknik Detaylar;

Pompa Beygir Gücü: 1,5 hp  
Pompa Gücü: 1,2 kW  
Çalışma Voltajı: 220V  
Faz: 1 (Monofaz)

### POMPA PAKET SİSTEMLERİ (3 Hp)

#### Paket nelerden oluşur?

- 18 Adet Polikristal Panel 275W
- 1 Adet 3 kW Solar Sulama Driver
- 1 Set Konstrüksiyon
- 30 Metre DC Solar Kablo

#### Teknik Detaylar;

Pompa Beygir Gücü: 3 hp  
Pompa Gücü: 2,2 kW  
Çalışma Voltajı: 380V  
Faz: 3 (Trifaz)

### POMPA PAKET SİSTEMLERİ (4 Hp)

#### Paket nelerden oluşur?

- 20 Adet Polikristal Panel 275W
- 1 Adet 4 kW Solar Sulama Driver
- 1 Set Konstrüksiyon
- 30 Metre DC Solar Kablo

#### Teknik Detaylar;

Pompa Beygir Gücü: 4 hp  
Pompa Gücü: 3 kW  
Çalışma Voltajı: 380V  
Faz: 3 (Trifaz)

### POMPA PAKET SİSTEMLERİ (5,5 Hp)

#### Paket nelerden oluşur?

- 21 Adet Polikristal Panel 275W
- 1 Adet 5,5 kW Solar Sulama Driver
- 1 Set Konstrüksiyon
- 30 Metre DC Solar Kablo

#### Teknik Detaylar;

Pompa Beygir Gücü: 5,5 hp  
Pompa Gücü: 4,1 kW  
Çalışma Voltajı: 380V  
Faz: 3 (Trifaz)

### POMPA PAKET SİSTEMLERİ (7,5 Hp)

#### Paket nelerden oluşur?

- 36 Adet Polikristal Panel 275W
- 1 Adet 7,5 kW Solar Sulama Driver
- 1 Set Konstrüksiyon
- 50 Metre DC Solar Kablo

#### Teknik Detaylar;

Pompa Beygir Gücü: 7,5 hp  
Pompa Gücü: 5,5 kW  
Çalışma Voltajı: 380V  
Faz: 3 (Trifaz)

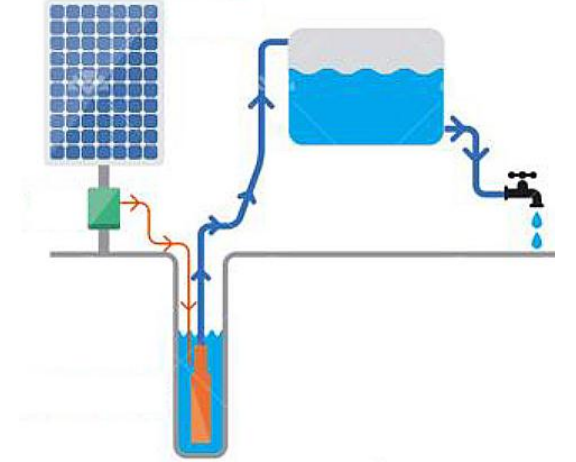

### POMPA PAKET SİSTEMLERİ (10 Hp)

#### Paket nelerden oluşur?

- 42 Adet Polikristal Panel 275W
- 1 Adet 11 kW Solar Sulama Driver
- 1 Set Konstrüksiyon
- 100 Metre DC Solar Kablo

#### Teknik Detaylar;

Pompa Beygir Gücü: 10 hp  
Pompa Gücü: 7,4 kW  
Çalışma Voltajı: 380V  
Faz: 3 (Trifaz)

### POMPA PAKET SİSTEMLERİ (15 Hp)

#### Paket nelerden oluşur?

- 60 Adet Polikristal Panel 275W
- 1 Adet 15 kW Solar Sulama Driver
- 1 Set Konstrüksiyon
- 100 Metre DC Solar Kablo

#### Teknik Detaylar;

Pompa Beygir Gücü: 15 hp  
Pompa Gücü: 11,2 kW  
Çalışma Voltajı: 380V  
Faz: 3 (Trifaz)

### POMPA PAKET SİSTEMLERİ (20 Hp)

#### Paket nelerden oluşur?

- 80 Adet Polikristal Panel 275W
- 1 Adet 18,5 kW Solar Sulama Driver
- 1 Set Konstrüksiyon
- 200 Metre DC Solar Kablo

#### Teknik Detaylar;

Pompa Beygir Gücü: 20 hp  
Pompa Gücü: 15 kW  
Çalışma Voltajı: 380V  
Faz: 3 (Trifaz)

### POMPA PAKET SİSTEMLERİ (25 Hp)

#### Paket nelerden oluşur?

- 100 Adet Polikristal Panel 275W
- 1 Adet 22 kW Solar Sulama Driver
- 1 Set Konstrüksiyon
- 300 Metre DC Solar Kablo

#### Teknik Detaylar;

Pompa Beygir Gücü: 25 hp  
Pompa Gücü: 18,6 kW  
Çalışma Voltajı: 380V  
Faz: 3 (Trifaz)

### POMPA PAKET SİSTEMLERİ (30 Hp)

#### Paket nelerden oluşur?

- 140 Adet Polikristal Panel 280W
- 1 Adet 30 kW Solar Sulama Driver
- 1 Set Konstrüksiyon
- 500 Metre DC Solar Kablo

#### Teknik Detaylar;

Pompa Beygir Gücü: 30 hp  
Pompa Gücü: 22,3 kW  
Çalışma Voltajı: 380V  
Faz: 3 (Trifaz)

### POMPA PAKET SİSTEMLERİ (40 Hp)

#### Paket nelerden oluşur?

- 160 Adet Polikristal Panel 275W
- 1 Adet 37 kW Solar Sulama Driver
- 1 Set Konstrüksiyon
- 500 Metre DC Solar Kablo

#### Teknik Detaylar;

Pompa Beygir Gücü: 40 hp  
Pompa Gücü: 29,8 kW  
Çalışma Voltajı: 380V  
Faz: 3 (Trifaz)

### POMPA PAKET SİSTEMLERİ (50 Hp)

#### Paket nelerden oluşur?

- 180 Adet Polikristal Panel 275W
- 1 Adet 45 kW Solar Sulama Driver
- 1 Set Konstrüksiyon
- 1000 Metre DC Solar Kablo

#### Teknik Detaylar;

Pompa Beygir Gücü: 50 hp  
Pompa Gücü: 37,3 kW  
Çalışma Voltajı: 380V  
Faz: 3 (Trifaz)

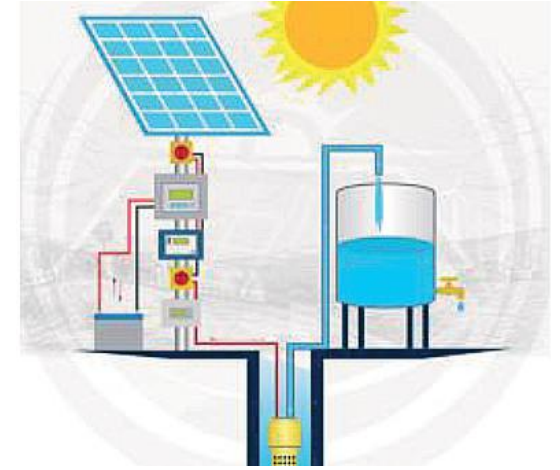

### POMPA PAKET SİSTEMLERİ (60 Hp)

#### Paket nelerden oluşur?

- 220 Adet Polikristal Panel 275W
- 1 Adet 55 kW Solar Sulama Driver
- 1 Set Konstrüksiyon
- 1000 Metre DC Solar Kablo

#### Teknik Detaylar;

Pompa Beygir Gücü: 60 hp  
Pompa Gücü: 44,7 kW  
Çalışma Voltajı: 380V  
Faz: 3 (Trifaz)

### POMPA PAKET SİSTEMLERİ (75 Hp)

#### Paket nelerden oluşur?

- 280 Adet Polikristal Panel 275W
- 1 Adet 75 kW Solar Sulama Driver
- 1 Set Konstrüksiyon
- 2000 Metre DC Solar Kablo

#### Teknik Detaylar;

Pompa Beygir Gücü: 75 hp  
Pompa Gücü: 56 kW  
Çalışma Voltajı: 380V  
Faz: 3 (Trifaz)

### POMPA PAKET SİSTEMLERİ (80 Hp)

#### Paket nelerden oluşur?

- 300 Adet Polikristal Panel 275W
- 1 Adet 75 kW Solar Sulama Driver
- 1 Set Konstrüksiyon
- 2500 Metre DC Solar Kablo

#### Teknik Detaylar;

Pompa Beygir Gücü: 80 hp  
Pompa Gücü: 60 kW  
Çalışma Voltajı: 380V  
Faz: 3 (Trifaz)

### POMPA PAKET SİSTEMLERİ (90 Hp)

#### Paket nelerden oluşur?

- 340 Adet Polikristal Panel 275W
- 1 Adet 90 kW Solar Sulama Driver
- 1 Set Konstrüksiyon
- 3000 Metre DC Solar Kablo

#### Teknik Detaylar;

Pompa Beygir Gücü: 90 hp  
Pompa Gücü: 67,1 kW  
Çalışma Voltajı: 380V  
Faz: 3 (Trifaz)

### POMPA PAKET SİSTEMLERİ (100 Hp)

#### Paket nelerden oluşur?

- 360 Adet Polikristal Panel 275W
- 1 Adet 90 kW Solar Sulama Driver
- 1 Set Konstrüksiyon
- 3000 Metre DC Solar Kablo

#### Teknik Detaylar;

Pompa Beygir Gücü: 100 hp  
Pompa Gücü: 74,6 kW  
Çalışma Voltajı: 380V  
Faz: 3 (Trifaz)

### POMPA PAKET SİSTEMLERİ (120 Hp)

#### Paket nelerden oluşur?

- 440 Adet Polikristal Panel 275W
- 1 Adet 110 kW Solar Sulama Driver
- 1 Set Konstrüksiyon
- 3500 Metre DC Solar Kablo

#### Teknik Detaylar;

Pompa Beygir Gücü: 120 hp  
Pompa Gücü: 89,5 kW  
Çalışma Voltajı: 380V  
Faz: 3 (Trifaz)

### POMPA PAKET SİSTEMLERİ (130 Hp)

#### Paket nelerden oluşur?

- 480 Adet Polikristal Panel 275W
- 1 Adet 110 kW Solar Sulama Driver
- 1 Set Konstrüksiyon
- 3500 Metre DC Solar Kablo

#### Teknik Detaylar;

Pompa Beygir Gücü: 130 hp  
Pompa Gücü: 97 kW  
Çalışma Voltajı: 380V  
Faz: 3 (Trifaz)

### POMPA PAKET SİSTEMLERİ (150 Hp)

#### Paket nelerden oluşur?

- 560 Adet Polikristal Panel 275W
- 1 Adet 132 kW Solar Sulama Driver
- 1 Set Konstrüksiyon
- 4000 Metre DC Solar Kablo

#### Teknik Detaylar;

Pompa Beygir Gücü: 150 hp  
Pompa Gücü: 112 kW  
Çalışma Voltajı: 380V  
Faz: 3 (Trifaz)

**X NEVA**  
**LIGHT**

“Enerjiye Dair Ne Varsa”





